

# Application of PreSTo: Aircraft Preliminary Sizing and Data Export to CEASIOM

**Kolja Seeckt**

*Department of Aeronautics, Kungliga Tekniska Högskolan (KTH, Royal Institute of Technology), Stockholm, Sweden*

16 February 2011

## Abstract

This report presents the application of the aircraft design software PreSTo (Preliminary Sizing Tool) to the re-design of a regional transport aircraft. The conducted work steps comprise aircraft design point definition, preliminary aircraft sizing, conceptual design of the aircraft components fuselage, wing and tailplane and the data export as well as the first work steps with the aircraft design software suite CEASIOM (Computerised Environment for Aircraft Synthesis and Integrated Optimisation Methods). The **reference aircraft for the aircraft re-design is the** regional turboprop aircraft **ATR 72** with a range of 500 NM (926 km) at a maximum payload of 8.1 t. The software statuses applied are PreSTo 3.3 (December 2010) and the CEASIOM version v2.0 (CEASIOM 100 R90).

The results obtained during the course of this project show that a good and promising start has been made towards a tool chain for a streamlined aircraft design and investigation from the very initial preliminary sizing (PreSTo) to aircraft stability and control simulation and beyond (CEASIOM). However, at the time of writing this report still much additional work stays necessary in order to optimize and simplify the working process over both programs and to yield trustworthy results. Inside PreSTo currently several aspects of aircraft design such as engine definition are not treated yet, so that an initial aircraft design with many data lacks must be exported to CEASIOM (AcBuilder). In consequence, much user interaction is necessary for model refinement. But also regarding the application of CEASIOM much work stays necessary to help the user apply the software correctly. Presently, one must have detailed knowledge on CEASIOM and the software structure in order to operate the program correctly. The user information given in the user interfaces as well as in the available tutorials is very limited and partly wrong or outdated. From this report's author's view it is very advisable for the developing teams of PreSTo and CEASIOM (at least AcBuilder) to interchange knowledge and experiences with the corresponding software tools, e.g. in the form of a user/developer workshop.

# Content

	Page
List of Figures .....	3
List of Tables.....	4
Nomenclature .....	4
List of Abbreviations.....	7
1 Introduction .....	8
1.1 Motivation and Aim of the Work .....	8
1.2 Work Structure .....	8
1.3 Previous Work and Additional Information .....	9
2 Tools and Reference Aircraft .....	9
2.1 PreSTo .....	9
2.2 CEASIOM .....	14
2.3 Reference Aircraft .....	20
3 Preliminary Sizing and Conceptual Design with PreSTo .....	22
3.1 Preliminary Sizing .....	22
3.1.1 Determination of the Aircraft Design Point .....	23
3.1.2 Sizing.....	30
3.2 Conceptual Design of the Fuselage .....	34
3.3 Conceptual Design of the Wing .....	37
3.4 Conceptual Design of the Tailplane .....	41
4 Data Export to CEASIOM .....	44
4.1 Aircraft Modeling with AcBuilder .....	45
4.1.1 Data Import from PreSTo.....	46
4.1.2 Aircraft Model Modification .....	49
4.1.3 AcBuilder Results.....	51
4.2 Geometry Export to SUMO .....	53
4.3 Aerodynamic Investigation with AMB .....	56
5 Findings and Future Work.....	58
Summary and Conclusions.....	60
References .....	61

## List of Figures

	Page
2.1	Aircraft Design Process ..... 10
2.2	PreSTo Preliminary Sizing Interface (Section Take-Off Shown) ..... 10
2.3	Example Matching Chart ..... 12
2.4	Display of a PreSTo-Result in CATIA V5 ..... 14
2.5	CEASIOM Virtual Aircraft Simulation Model ..... 15
2.6	xml-Data Example ..... 15
2.7	AcBuilder User Interface ..... 16
2.8	AMB User Interface ..... 17
2.9	Propulsion User Interface ..... 17
2.10	SDSA User Interface ..... 18
2.11	NeoCASS User Interface ..... 18
2.12	Exemplary NeoCASS Result ..... 19
2.13	SUMO User Interface ..... 20
2.14	ATR 72 ..... 21
3.1	Propeller Efficiency Versus Airspeed and Propeller Disc Loading ..... 25
3.2	Preliminary Sizing Matching Chart ..... 29
3.3	Presentation of the Preliminary Sizing Results in PreSTo ..... 33
3.4	Fuselage Cross Section Sketch ..... 35
3.5	Original ATR 72 Cabin Floor Plan ..... 36
3.6	Cabin Floor Plan Definition Inside PreSTo ..... 36
3.7	PreSTo Cabin Floor Plan and Fuselage Outer Contour ..... 37
3.8	Wing Sweep Suggestion ..... 38
3.9	Wing Taper Ratio Suggestion ..... 38
3.10	Front View Sketch ..... 39
3.11	Wing Airfoil Selection ..... 40
3.12	Wing Planform Including Aileron and Flaps ..... 41
3.13	Horizontal Tail Planform Including Elevator ..... 42
3.14	Horizontal Tail Airfoil Selection ..... 43
3.15	Vertical Tail Including Rudder ..... 44
4.1	PreSTo-Worksheet “CEASIOM” ..... 45
4.2	PreSTo Result Imported into AcBuilder -1 ..... 49
4.3	PreSTo Result Imported into AcBuilder -2 ..... 49
4.4	Aircraft Geometry after Modification ..... 50
4.5	Specification of Fuel Tanks and Masses ..... 51
4.6	Overall Geometric Results ..... 51
4.7	Structural Beam Model ..... 52
4.8	Aerodynamic Panel Model ..... 53
4.9	SUMO Aircraft Model and Surface Mesh ..... 54

4.10	SUMO Example of Surface Mesh Error Messages -1.....	54
4.11	SUMO Example of Surface Mesh Error Messages -2.....	54
4.12	SUMO Example of Volume Mesh Error Messages -1 .....	55
4.13	SUMO Example of Volume Mesh Error Messages -2.....	55
4.14	Example of MATLAB Error Messages (AMB: GEO TORNADO) -1.....	56
4.15	Example of MATLAB Error Messages (AMB: GEO TORNADO) -2.....	56
4.16	AMB Drag Coefficient Result (DATCOM).....	57
4.17	AMB Lift Coefficient Result (DATCOM).....	57

## List of Tables

		Page
2.1	ATR 72 Key Characteristics.....	21
2.2	ATR 72 Characteristic Missions .....	22
3.1	Preliminary Sizing Top-Level Aircraft Requirements (TLARs) .....	22
3.2	Flight Segment Fuel Fractions.....	31
3.3	Preliminary Sizing – Cruise Flight Conditions .....	32
3.4	Preliminary Sizing – Aircraft Design Points .....	32
3.5	Preliminary Sizing – Aircraft Parameters.....	33
3.6	Passenger, Passenger Seat and Cabin Aisle Dimensions .....	34
3.7	Fuselage Cross Section Dimensions.....	35
3.8	Fuselage Outer Contour Definition .....	37
3.9	Wing Geometry Parameters .....	39
3.10	Aileron Data and PreSTo Suggestions .....	40
3.11	Horizontal Tail Data and PreSTo Suggestions.....	42
3.12	Vertical Tail Data and PreSTo Suggestions .....	43

## Nomenclature

<i>A</i>	Aspect ratio
<i>a</i>	Speed of sound
	Correlation of power-to-mass (thrust-to-weight) ratio to wing loading for take-off field length requirement
<i>b</i>	Span
<i>C</i>	Coefficient
<i>c</i>	Specific fuel consumption
<i>E</i>	Glide ratio (= lift-to-drag ratio)

$e$	Euler's number Oswald efficiency factor
$g$	Gravitational acceleration
$h$	Altitude
$k$	(Statistical) correlation factor
$L$	Propeller disc loading
$l$	Length
$M$	Mach number
$M_{FF}$	Mission (segment) fuel fraction
$m$	Mass
$\frac{m_{MTO}}{S_W}$	Wing loading
$n$	Number
$P$	Power
$\frac{P_{TO}}{m_{MTO}}$	Power-to-mass ratio
$p$	Pressure
$R$	Range Breguet range factor
$S$	Area
$s$	Distance
$T$	Thrust
$\frac{T_{TO}}{m_{MTO} \cdot g}$	Thrust-to-weight ratio
$t$	Breguet endurance factor Time
$V$	Airspeed
$V_2$	2 <sup>nd</sup> segment flight speed

## Greek

$\gamma$	Climb angle
$\eta$	Efficiency
$\kappa$	Heat capacity ratio (= ratio of specific heats)
$\rho$	Air density
$\sigma$	Relative air density

## Indices

0	At sea level
<i>2nd</i>	Second flight segment
<i>AIR</i>	Air
<i>ALT</i>	To alternate airport
<i>APP</i>	Approach
<i>CARGO</i>	Cargo
<i>CLB</i>	Climb
<i>CR</i>	Cruise flight
<i>D</i>	(Propeller) disc Drag
<i>DES</i>	Descent
<i>D, P</i>	Parasite drag
<i>E</i>	Engine(s) Glide ratio
<i>E – START</i>	Engine startup
<i>L</i>	Landing Lift
<i>LFL</i>	Landing field length
<i>LOITER</i>	Loiter
<i>MAPP</i>	Missed approach
<i>MAX</i>	Maximum
<i>MD</i>	Minimum drag
<i>ML</i>	Maximum landing
<i>MTO</i>	Maximum take-off
<i>MZF</i>	Maximum zero fuel
<i>OE</i>	Operating empty
<i>P</i>	Propeller
<i>PAX</i>	Passengers
<i>PL</i>	Payload
<i>REQ</i>	Required
<i>RES</i>	Reserves
<i>SA</i>	Seats abreast
<i>STD</i>	Standard (flight)
<i>TAXI</i>	Taxi
<i>TO</i>	Take-off
<i>TOFL</i>	Take-off field length
<i>W</i>	Wing
<i>WET</i>	Wetted (area)

## List of Abbreviations

AcBuilder	Aircraft Builder
AMB	Aerodynamic Model Builder
CEASIOM	Computerised Environment for Aircraft Synthesis and Integrated Optimisation Methods
CFD	Computational Fluid Dynamics
CG	Center of Gravity
CS	Certification Specifications
DATCOM	United States Air Force Stability and Control Data Compendium
EASA	European Aviation Safety Agency
FAA	Federal Aviation Administration
FAR	Federal Aviation Regulations
FCSDT	Flight Control System Designer Toolkit
FOI	Totalförsvarets forskningsinstitut (Swedish Defense Research Agency)
GF	Green Freighter
GND	Ground
HTP	Horizontal Tailplane
ISA	International Standard Atmosphere
MAC	Mean Aerodynamic Chord
NeoCASS	Next generation Conceptual Aero-Structural Sizing
OEI	One Engine Inoperative
PreSTo	Preliminary Sizing Tool
SDSA	Simulation and Dynamic Stability Analysis
SL	Sea Level
SUMO	Surface Modeling Tool for Aircraft Configurations
TLAR	Top-Level Aircraft Requirement
VTP	Vertical Tailplane

# 1 Introduction

## 1.1 Motivation and Aim of the Work

This report aims at illustrating the combined application of the aircraft design tools PreSTo and CEASIOM. Both aircraft design programs were developed separately. Discussions between the users and developers of these tools however showed that a possibility for a data exchange or at least data export from PreSTo to CEASIOM is desirable. PreSTo offers the user the possibility to generate new aircraft designs quickly and easily with much assistance of the tool during the selection and determination of unknown aircraft parameters. The depth of the design and investigation capability of PreSTo however is limited. CEASIOM, in contrast, is capable of many aircraft investigations of greater fidelity but requires a basic parametric aircraft description to start from, but how to create such an initial aircraft layout is not treated within the scope of CEASIOM. Hence, besides the pure description of the individual work flow, the aim of this report is to identify areas for future work in order to develop an integrated aircraft design software chain. The software versions used for the work presented in this report are PreSTo 3.3 (December 2010) and the CEASIOM version v2.0 (CEASIOM 100 R90).

## 1.2 Work Structure

This report is split up into five sections treating the individual aspects of the conducted study.

- Section 2** introduces the aircraft design software PreSTo and the CEASIOM software suite as well as the reference aircraft for the presented aircraft design investigations.
- Section 3** describes the preliminary sizing and conceptual re-design based on the selected reference aircraft to illustrate the work with PreSTo.
- Section 4** describes the data export from PreSTo to CEASIOM and presents the necessary user interaction during the first work steps inside CEASIOM.
- Section 5** collects the most important findings throughout the application of CEASIOM and delivers suggestions for the previous work on PreSTo, CEASIOM in general and the individual CEASIOM software components.



## 1.3 Previous Work and Additional Information

The Preliminary Sizing Tool PreSTo evolved from the aircraft design research project “The Green Freighter” (GF, see **Scholz 2010**) that was conducted under the lead of the Hamburg University of Applied Sciences (HAW Hamburg) from December 2006 to April 2010. During this project several designs of regional and long-range freighter aircraft were set up and investigated using PreSTo. One of the first reports on the development of PreSTo is **Seeckt 2008**, in which a Boeing B777 is re-sized and additional emphasis is given to the fuselage design. The investigation steps presented in the report were the first extensions to the previously existing preliminary sizing tool from HAW Hamburg, which in the meantime has become PreSTo. Many further student projects from HAW Hamburg and partner universities followed and contributed additional extensions to the tool. These projects on individual aspects of the improvement of PreSTo were supervised by the author of this report. The project reports are available for download from **Scholz 2010a**. Previous applications of PreSTo were presented e.g. on the German Aerospace Conferences 2009 and 2010 in Aachen and Hamburg and the ICAS Congress 2010 in Nice (**Seeckt 2009a**, **Seeckt 2010**, **Seeckt 2010a**).

Regarding the work with CEASIOM the author of this report has been in contact with the CEASIOM community since 2007 or CEASIOM version 48. The actual state of the work with CEASIOM including user feedback, findings and suggestions for future work were e.g. presented on a CEASIOM users meeting in Liverpool in April 2009 (**Seeckt 2009**). Moreover, the author tutored the master thesis **Pester 2010** at HAW Hamburg that deals with the application of CEASIOM to the re-design and modification of an Airbus A320. For further information on the application of CEASIOM beyond the scope of this report especially this project is recommended to the reader.

## 2 Tools and Reference Aircraft

### 2.1 PreSTo

The Aircraft Preliminary Sizing Tool PreSTo is a spreadsheet application for the quick preliminary sizing and conceptual design of transport aircraft. PreSTo has been developed at the Hamburg University of Applied Sciences (HAW Hamburg) and follows the aircraft design process as taught in the aircraft design lecture by Prof. Dieter Scholz (**Scholz 2010b**, see Figure 2.1). Detailed information on PreSTo is given on the PreSTo-website (**Scholz 2010c**); moreover, a simplified version for the standalone conceptual design of aircraft fuselages and cabins is available for download there.

PreSTo consists of a set of Microsoft Excel worksheets of which each one treats an individual design step. Figure 2.2 shows an example screenshot of the PreSTo user interface. White cells mark required user input. Grey cells indicate calculated data, and the command buttons in the presented cutout link to worksheets containing statistical data on real aircraft.

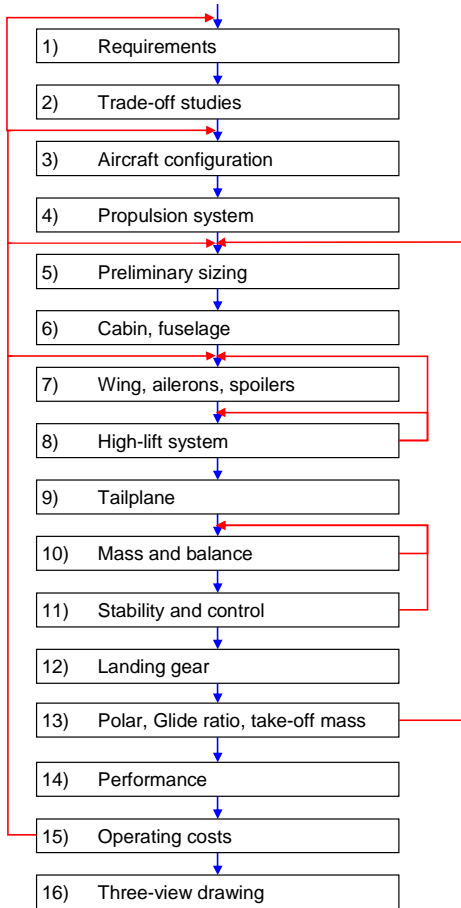

Figure 2.1 Aircraft Design Process

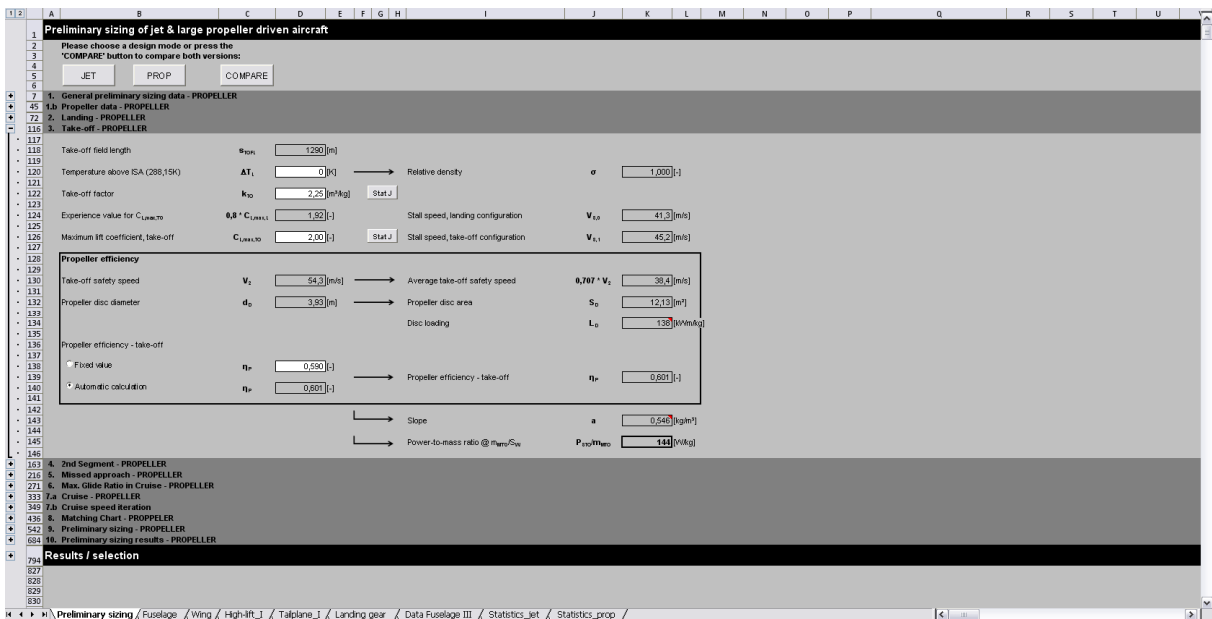

Figure 2.2 PreSTo Preliminary Sizing User Interface (Section Take-Off Shown)

### Steps 1 to 4

The aircraft design process starts with the determination of the Top-Level Aircraft Requirements (TLARs) posed to the new aircraft and trade-off studies with existing aircraft in order to establish the desired market niche (Steps 1 and 2). Subsequently, the aircraft designer has to make the general decisions of which configuration the aircraft shall be built in (tail-aft/unconventional) and which type of propulsions system shall be used (jet/turboprop) (Steps 3 and 4).

### Step 5

In Step 5 follows the aircraft preliminary sizing. The preliminary sizing is the core part of PreSTo and is based on a set of Microsoft Excel worksheets used for the aircraft design lecture at HAW Hamburg (**Scholz 2010b**). Inside PreSTo an empirical propeller efficiency model is used to express the propeller efficiency  $\eta_p$ , which is needed for the preliminary sizing of propeller-driven aircraft. The first result of the preliminary sizing is the aircraft design point. It is expressed in terms of

- Wing loading  $\frac{m_{MTO}}{S_w} \left[ \frac{\text{kg}}{\text{m}^2} \right]$  and
- Power-to-mass ratio  $\frac{P_{TO}}{m_{MTO}} \left[ \frac{\text{W}}{\text{kg}} \right]$  in case of propeller-driven aircraft or
- Thrust-to-weight ratio  $\frac{T_{TO}}{m_{MTO} \cdot g} [-]$  in case of jet-driven aircraft.

For this purpose, the five major requirements

- Landing field length  $s_{LFL}$ ,
- Take-off field length  $s_{TOFL}$ ,
- Climb gradient after take-off (second segment)  $\sin(\gamma_{2nd})$ ,
- Climb gradient after missed approach  $\sin(\gamma_{MAPP})$  and
- Cruise Mach number  $M_{CR}$

are expressed as functions of wing loading and thrust-to-weight ratio (resp. power-to-mass ratio in case of propeller-driven aircraft) and put together in one matching chart (see Figure 2.3). As PreSTo treats the design of civil transport aircraft the Certification Specifications CS-25 of the EASA (**EASA 2010**) and the FAR Part 25 of the US American FAA (**FAA 2011**) are used as certification bases.

From the matching chart the aircraft design point is read. The design point must fulfill all requirements simultaneously, i.e. it must lie above the line of each requirement and left of the landing field length requirement. In first priority a small thrust-to-weight ratio is chosen (i.e. small engines), and in second priority a large wing loading is chosen (i.e. a small wing).

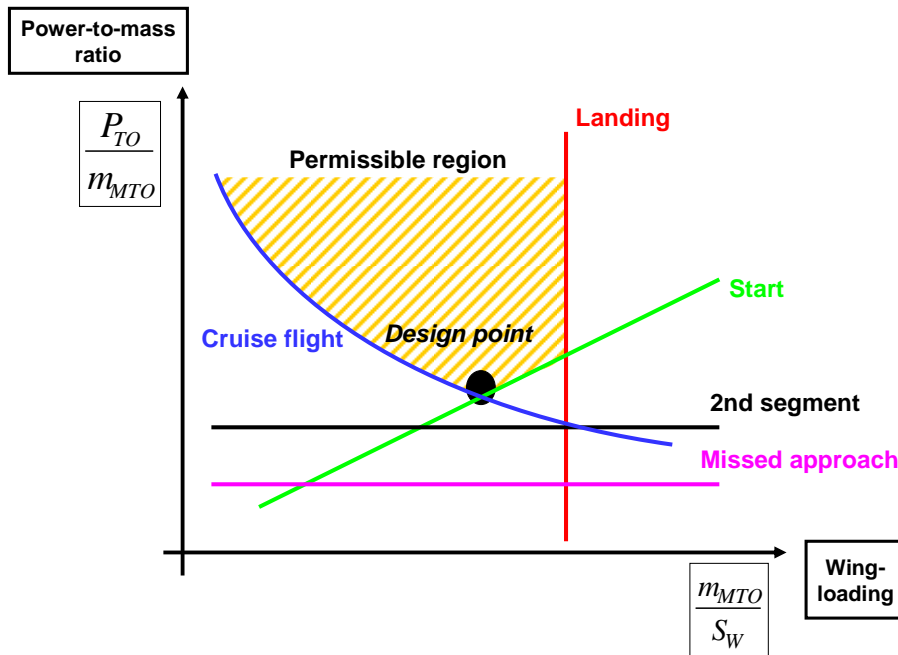

**Figure 2.3** Example Matching Chart

After the determination of the aircraft design point the new aircraft is sized. For this purpose a reference mission is used that defines how much payload  $m_{PL}$  has to be transported over which design range  $R$  and with which reserves (international fuel reserves, loiter time, distance to alternate airport). The results of the preliminary sizing design step are

- The maximum take-off mass, operating empty mass and maximum landing mass of the aircraft,
- The amount of fuel required for the given reference mission,
- The wing area and
- The required take-off power (resp. thrust in case of jet aircraft) of the engines.

During the whole preliminary sizing process the aircraft was regarded as a point mass. This changes in the following Steps 6 to 9 in which the aircraft components are sized.

### Step 6

The first aircraft component to be dimensioned is the fuselage including the cabin. The fuselage is sized first as this step may occur independently from the following aircraft components. The maximum number of passengers to be transported is used in combination with comfort standards and the mentioned certification requirements to obtain a fuselage cross section and a cabin layout. Moreover, in case the aircraft design shall feature a lower deck cargo compartment different cargo containers may be displayed to check for geometrical integrity of the designed fuselage cross section. Details on the implementation and work with this PreSTo component are given in **Goderis 2008** and **Seeckt 2008**.

The initial value for the determination of a fuselage diameter and cross section is determined by a statistical relationship between the number of passengers and the number of seats per seat row ('seats abreast')  $n_{SA}$ . From this value a cabin diameter is determined in combination with the dimensions of a standard passenger, seat width and aisle width. The subsequent steps during fuselage design are the definition of a cabin length and layout including the arrangement of the seat rows as well as additional space for exits, lavatories and galleys.

### **Step 7 to 8**

Design Step 7 contains the sizing and shaping of the wing according to the cruise Mach number requirement. The shaping includes suggestions for wing parameters such as wing sweep, wing taper ratio and relative airfoil thickness and the selection of an airfoil from a catalogue of currently 122 airfoils. Moreover, first estimations of the aileron size and position are prepared by means of the so-called aileron volume, which is defined as the sum of aileron areas times their lever arms. In Step 8 'High-lift' the high-lift devices are sized and positioned based on the required lift coefficient  $C_L$  used during the preliminary sizing. The methods used in these design steps are taken from the aircraft design lecture (**Scholz 2005, Scholz 2008**) as well as further handbooks on aircraft design (**Howe 2005, Raymer 1999, Torenbeek 1988, Roskam 1990**). Details on the implementation of the design steps 'Wing' and 'High-lift' into PreSTo are given in **Coene 2008**.

### **Step 9**

Design Step 9 'Tailplane' deals with the sizing of the stability and control surfaces in different levels of accuracy ranging from quick statistical handbook methods (**Scholz 2005, Howe 2005, Raymer 1999, Torenbeek 1988**) to the application of the stability and control data compendium DATCOM published by the US Air Force Flight Dynamics Laboratory (**Hoak 1978**).

The geometric definition process of the horizontal and vertical tails is very similar to the process of the wing description. As first step the user selects a general arrangement of the tailplane: conventional, T-tail or H-tail. Afterwards, the sizes and positions of the horizontal and vertical tails are estimated using the volume method as in case of the ailerons earlier. Also the airfoils of the horizontal and vertical stabilizers may be selected from the airfoil catalogue. Details on the setup of this design step can be found in **Coene 2008**.

### **Step 10 to 16**

The following steps 10 and 11 contain the calculation of the aircraft's masses and its flight performance and stability and control characteristics. Now that the aircraft masses, its center of gravity (CG) and the angles of attack during take-off and landing are known the landing gear may be sized and positioned in Step 12, and the aircraft's flight performance characteristics are determined in Steps 13 and 14. As the last steps of the aircraft design process the resulting operating costs are determined (Step 15). When finally all requirements

are met drawings of the fuselage cross section, cabin layout and a three-view drawing as well as tables of the aircraft's parameters and operational characteristics are prepared in Step 16.

### Data Export

PreSTo offers the possibility to export results to further aircraft design or CAD programs in order to display, analyze or improve the PreSTo results. The possible programs for data export are PrADO, CEASIOM and CATIA V5. Details on the data preparation for the export of data to the individual programs are given in **Luthra 2009** (PrADO), **Lenarczyk 2009** (CEASIOM) and **Pommers 2010** (CATIA V5, Figure 2.4).

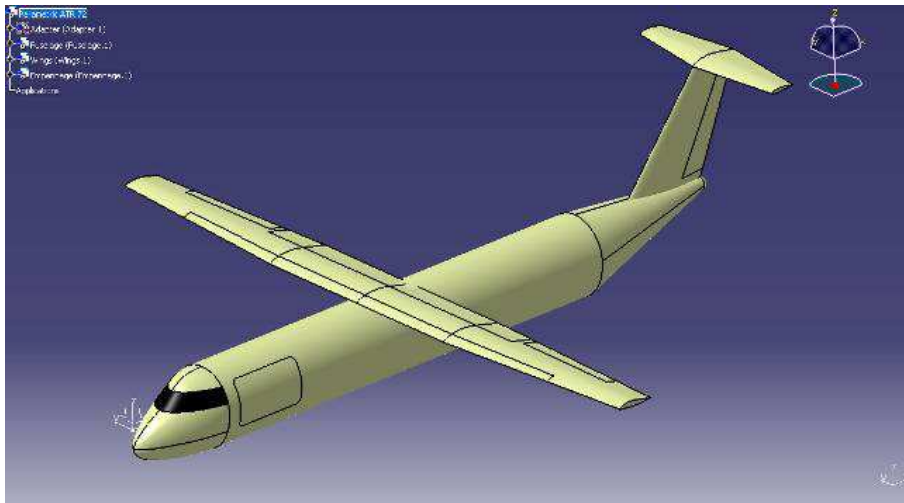

**Figure 2.4** Display of a PreSTo-Result in CATIA V5 (**Pommers 2010**)

## 2.2 CEASIOM

CEASIOM (Computerised Environment for Aircraft Synthesis and Integrated Optimisation Methods) is a MATLAB-based aircraft design software suite developed for flight mechanical and aeroelasticity investigations of aircraft designs very early in the aircraft design process. CEASIOM comprises the modeling and analysis of the aircraft geometry and flight control system and derives information about the aircraft masses and loads, stability and control characteristics, flight performance and the aircraft's aeroelastic properties (see Figure 2.5).

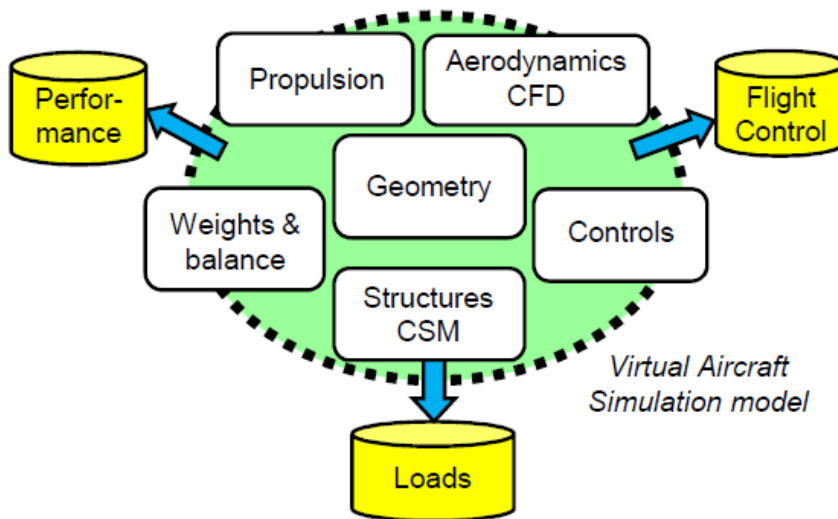

**Figure 2.5** CEASIO Virtual Aircraft Simulation Model (CEASIO 2010)

The program package as well as basic user guides on the individual tools (except for AMB and FCSDT) is available for download from the CEASIO website **CEASIO 2010a**.

CEASIO consists of seven individual design tools (AcBuilder, SUMO, AMB, Propulsion, NeoCASS, SDSA and FCSDT) that share one integrated aircraft model stored in xml data format.

### AcBuilder

AcBuilder (Aircraft builder) is the central aircraft modeling tool. In this tool the aircraft geometry is modeled parametrically and the basic aircraft mass estimations are performed for later use in the following tools. The aircraft model data are stored as xml-file (see Figure 2.6).

```
<root xml_tb_version="3.2.1" idx="1" type="struct" size="1 1">
```

**Figure 2.6** xml-Data Example

Figure 2.7 shows the AcBuilder user interface. On the left side the current aircraft geometry is displayed. In the upper right part the user selects which possible aircraft components shall be included in the current model (e.g. one or two wings). The lower right window of the AcBuilder user interface displays the actual aircraft geometry parameters and calculated results (e.g. wing aspect ratio from wing area and span).

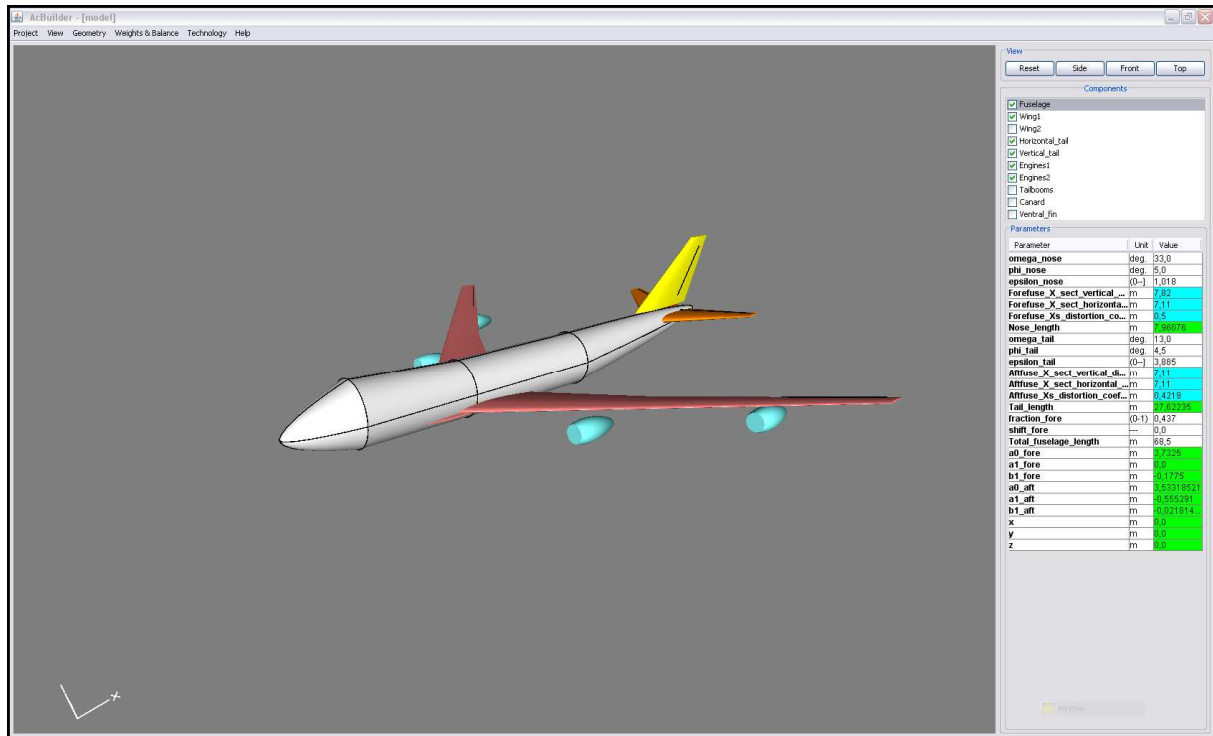

**Figure 2.7** AcBuilder User Interface

## AMB

The Aerodynamic Model Builder (AMB) controls the calculation and display of the aerodynamic aircraft characteristics such as the development of lift and drag over angle of attack. The user may currently choose between three methods. These are the vortex lattice solver Tornado, the empiric program Digital DATCOM of the US Air Force and the CFD flow solver EDGE of the Swedish Defense Research Agency FOI. In case EDGE is to be used as CFD solver a CFD mesh must be prepared using the tool SUMO (see below) previously. Tornado and DATCOM do not require a detailed mesh, thus these solvers may be run directly after AcBuilder. Figure 2.8 shows the AMB user interface. The upper left part depicts the simplified aerodynamic aircraft model or a selected aerodynamic plot. The upper right part shows which necessary data are already loaded into AMB; below, the three calculation tools DATCOM, Tornado (labeled “Potential Solver”) and EDGE are controlled and started.



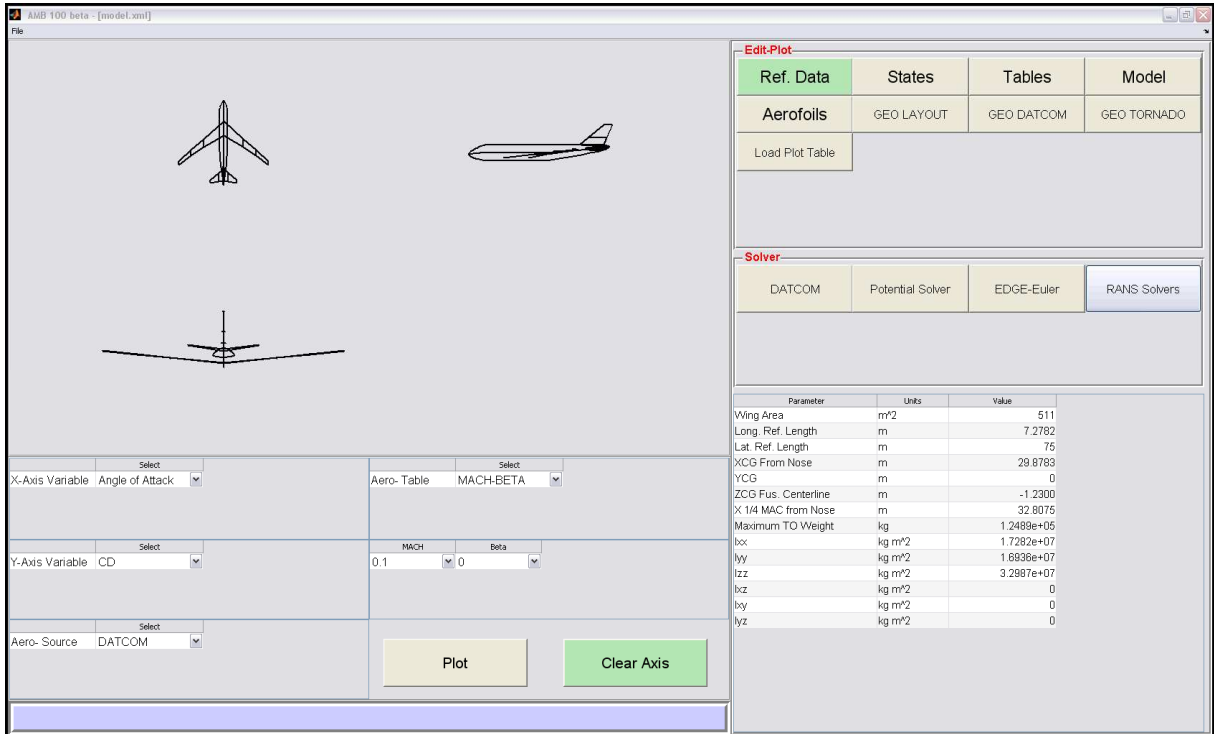

Figure 2.8 AMB User Interface

## Propulsion

The Propulsion tool calculates engine performance data over Mach number and altitude that are required for the following tool SDSA (see Figure 2.9). The user interaction is limited to the input of the desired calculation nodes in terms of Mach number and altitude (in km).

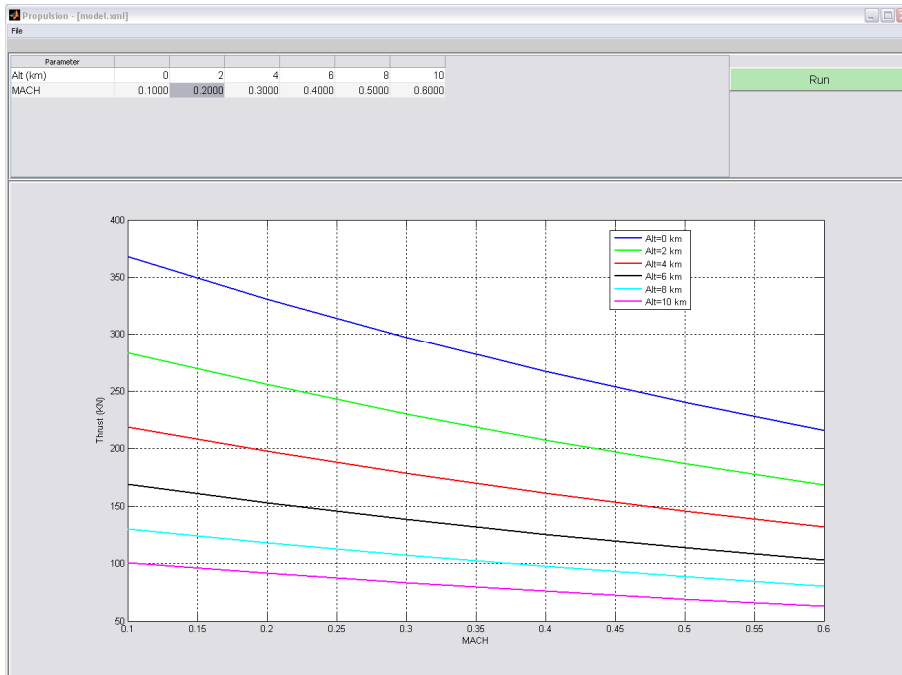

Figure 2.9 Propulsion User Interface

## SDSA

SDSA (Simulation and Dynamic Stability Analysis) is a flight simulation tool of the actual aircraft design. The tool uses the data generated by AMB and Propulsion and uses the aircraft geometry defined in AcBuilder. Using SDSA the stability and control characteristics of the current aircraft design may be displayed and assessed (see Figure 2.10).

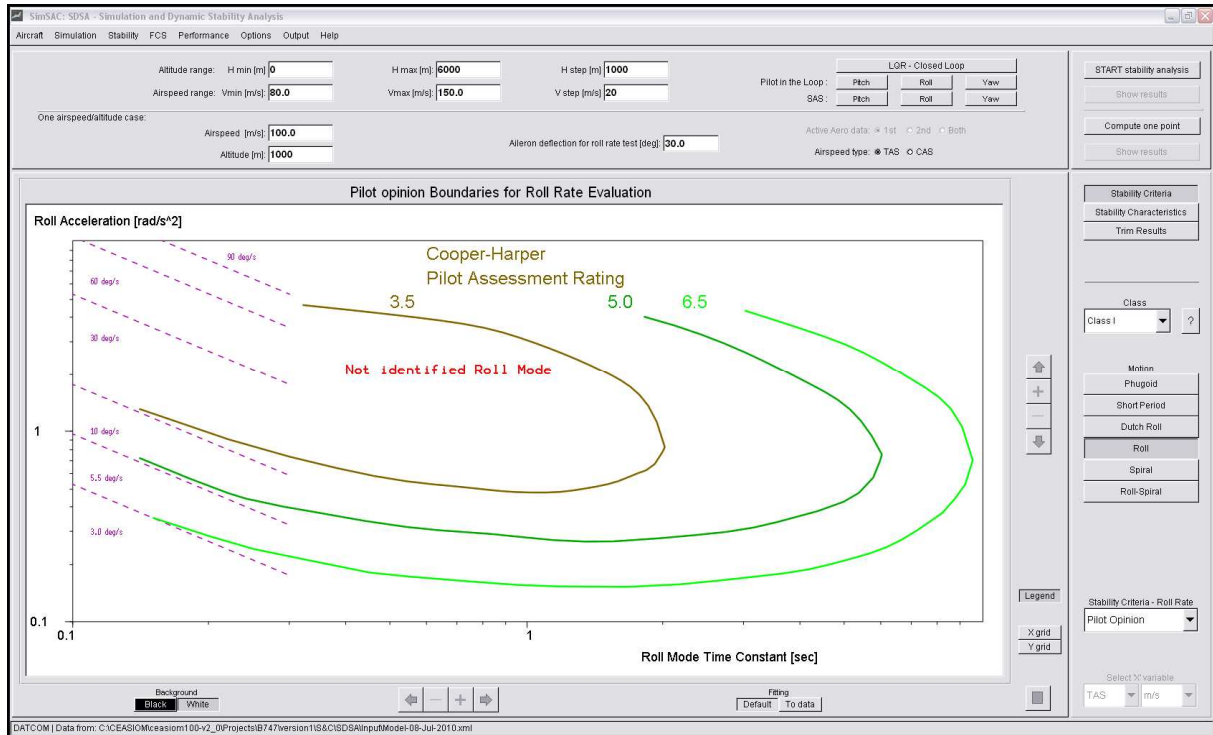

Figure 2.10 SDSA User Interface

## NeoCASS

NeoCASS (Next generation Conceptual Aero-Structural Sizing) performs the aeroelastic analysis of the current aircraft design. It uses the defined aircraft structure in combination with the occurring aerodynamic loads to identify typical modes of static and dynamic structural deformation. The Figures 2.11 and 2.12 show the NeoCASS user interface and an exemplary NeoCASS result.

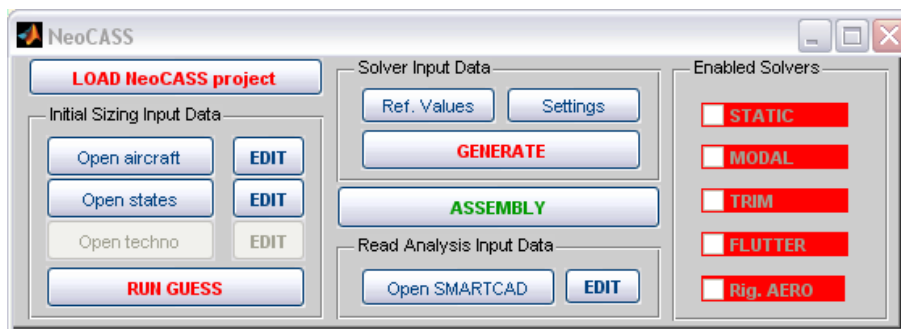
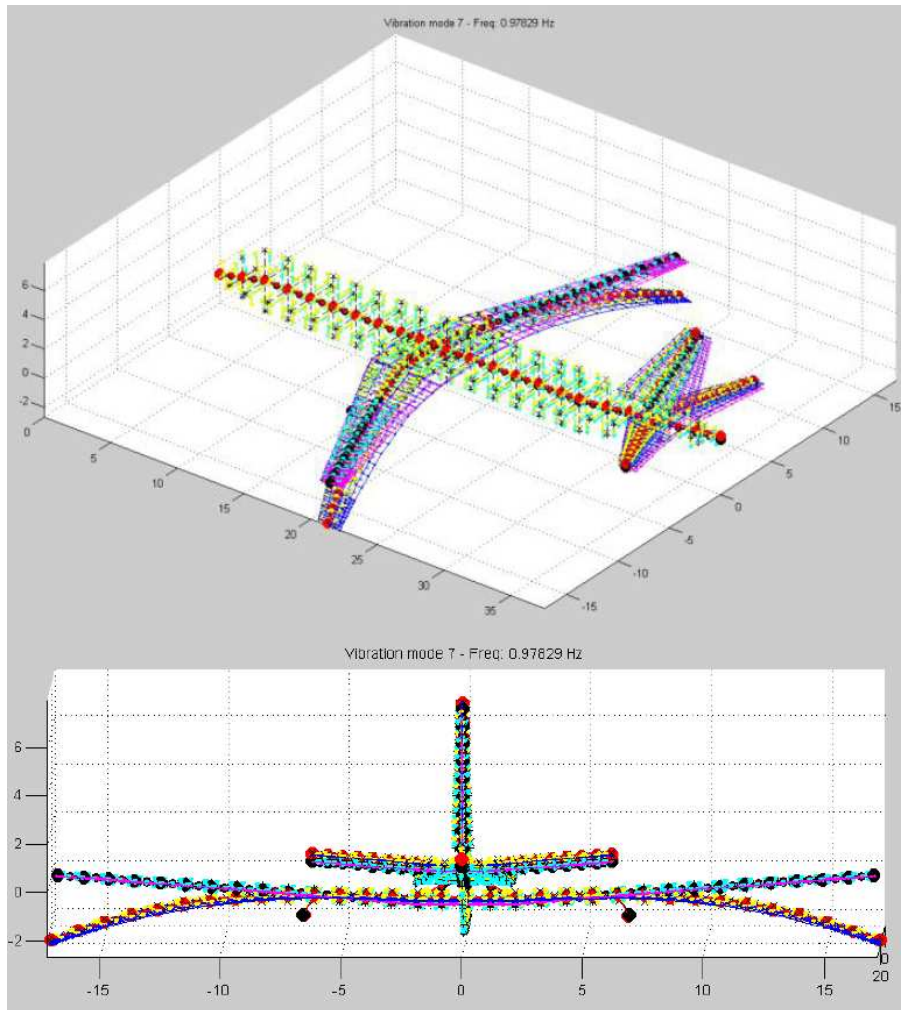

Figure 2.11 NeoCASS User Interface



**Figure 2.12** Exemplary NeoCASS Result (Pester 2010)

## SUMO

SUMO (Surface Modeling Tool for Aircraft Configurations) is a mesh generator required for higher fidelity CFD analyses of the actual aircraft design (within the CEASIOM package: EDGE). Under normal conditions and if the user is satisfied with the simplified aircraft geometry defined in AcBuilder (especially nose section) the CFD mesh may be generated directly. Figure 2.13 shows the SUMO user interface.

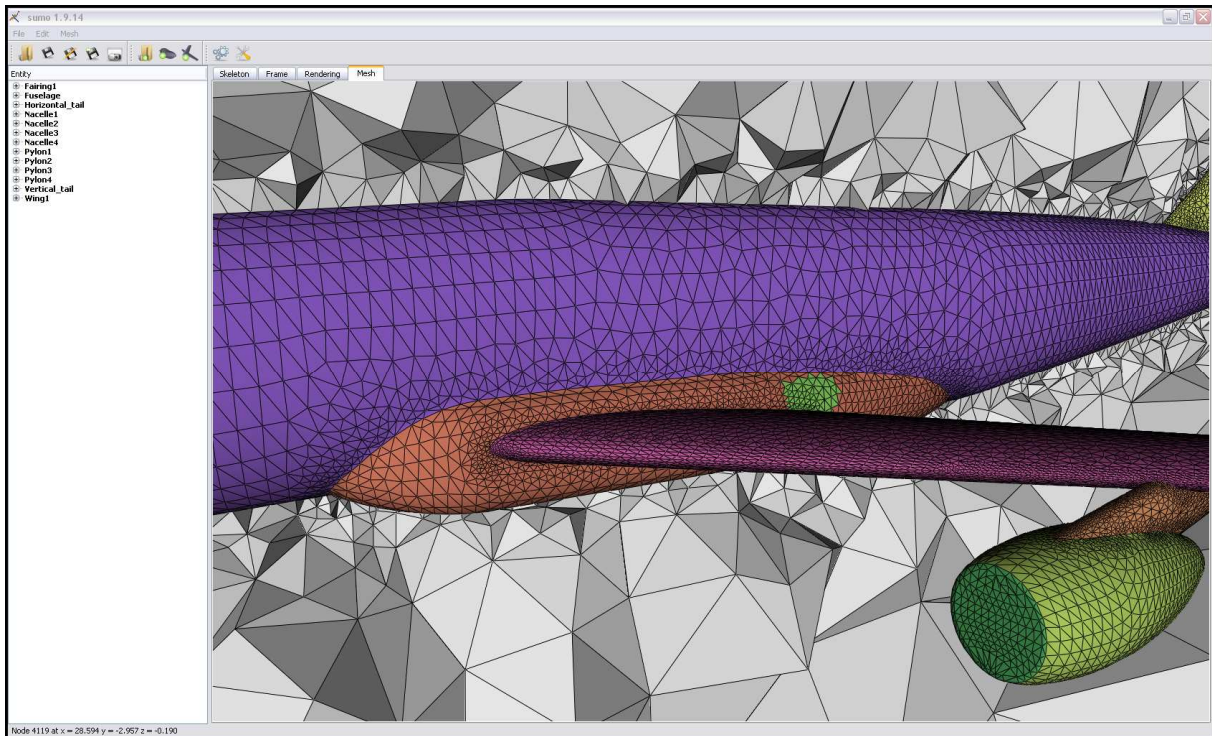

**Figure 2.13** SUMO User Interface

### FCSDT

The Flight Control System Designer Toolkit (FCSDT) is intended to support the user in designing the aircraft flight control system and to allow for an assessment of the flight control system reliability. In the CEASIOM version underlying this report (CEASIOM100 R90) this tool is still in preparation and only very limitedly applicable. It is not treated any further in this report.

## 2.3 Reference Aircraft

The reference aircraft for the studies presented in this report was selected to be the ATR 72 (see Figure 2.14). The ATR 72 is a stretched version of the ATR 42. It is built in T-tail configuration and driven by two Pratt & Whitney PW 127F turboprop engines with four- or six-blade propellers dependant on the aircraft version. It features a double-trapezoid wing in high-wing configuration with constant-chord inner and tapered outer sections. As high-lift devices double-slotted flaps are used. Most of the secondary structure is manufactured from composite materials, summing up to 19 percent of the overall structural mass (ATR 2005). The aircraft's technical key characteristics are summarized in Table 2.1.



**Figure 2.14** ATR 72 (Wikipedia 2010)

**Table 2.1** ATR 72 Key Characteristics (Jackson 2008, ATR 2003, ATR 2003a)

Characteristic	Symbol	Unit	Value
Length	$l$	m	27.2
Wing span	$b$	m	27.1
Wing area	$S_W$	m <sup>2</sup>	61
Wing aspect ratio	$A$	-	12
Engine take-off power	$P_{TO}/n_E$	kW	2,051
Typical number of passengers	$n_{PAX}$	-	72
Operating empty mass	$m_{OE}$	t	11.9
Maximum payload	$m_{PL}$	t	8.1
Maximum zero-fuel mass	$m_{MZF}$	t	20
Maximum take-off mass	$m_{MTO}$	t	22
Maximum landing mass	$m_{ML}$	t	21.35
Take-off field length	$s_{TOFL}$	m	1,290*
Landing field length	$s_{LFL}$	m	1,067*
Typical cruise Mach number	$M_{CR}$	-	0.41

\*\* ISA, SL

The characteristic flight missions of the ATR 72 are collected in Table 2.2. The mission ‘Range at Maximum Payload’ (8.1 t of payload over 500 NM range) was selected as the reference mission for the following aircraft investigations.

**Table 2.2** ATR 72 Characteristic Missions (**ATR 2003a**)

Mission	Payload	Range
Range at maximum payload	8.1 t	500 NM (926 km)
Range at maximum fuel	5.1 t	1,830 NM (3,390 km)
Ferry range	0 t	2,150 NM (3,980 km)

### 3 Preliminary Sizing and Conceptual Design with PreSTo

This section presents PreSTo, its structure and its application to the preliminary sizing and conceptual design of a propeller-driven regional aircraft. The aircraft designs in this section are all treated as ‘all-new’ designs, which means that the aircraft parameters are determined freely without restrictions from e.g. an aircraft family concept.

#### 3.1 Preliminary Sizing

As selected in Section 2.3 the reference aircraft for the application of PreSTo is the ATR 72. The TLARs that result from this selection are listed in Table 3.1.

**Table 3.1** Preliminary Sizing Top-Level Aircraft Requirements (TLARs)

TLAR	Symbol	Unit	Value
Range	$R$	km	926
Number of passengers	$n_{PAX}$	-	72
Additional freight	$m_{CARGO}$	kg	1400
Cruise Mach number	$M_{CR}$	-	0.447
Take-off field length (ISA, SL)	$s_{TOFL}$	m	1,290
Landing field length (ISA, SL)	$s_{LFL}$	m	1,067
Second segment climb gradient	$\sin(\gamma_{2nd})$	-	Acc. to CS-25 and FAR Part 25
Missed approach climb gradient	$\sin(\gamma_{MAPP})$	-	Acc. to CS-25 and FAR Part 25

### 3.1.1 Determination of the Aircraft Design Point

An aircraft's design point in terms of wing loading  $m_{MTO}/S_w$  and power-to-mass ratio  $P_{TO}/m_{MTO}$  in case of propeller-driven aircraft is determined by the following five TLARs:

- Take-off field length  $s_{TOFL}$
- Landing field length  $s_{LFL}$
- Second segment climb gradient  $\sin(\gamma_{2nd})$
- Missed approach climb gradient  $\sin(\gamma_{MAPP})$
- Cruise Mach number  $M_{CR}$ .

The requirements are processed successively in this section and put together in one matching chart per aircraft from which the aircraft design points are read. Detailed descriptions of the process and the equations applied can be found in **Scholz 2005**, **Seeckt 2008** and **Niță 2008**.

#### Landing Field Length

The landing field length requirement determines a maximum value of the wing loading and consequently a minimum size of the wing according to Equation 3.1. The necessary input data are the required landing field length  $s_{LFL}$ , the maximum landing lift coefficient  $C_{L,ML}$ , the relative air density  $\sigma$ , the fraction of maximum landing to maximum take-off mass  $m_{ML}/m_{MTO}$  and a statistical landing factor  $k_L$  that describes the braking capability of an aircraft.

$$\frac{m_{MTO}}{S_w} = \frac{m_{ML}/S_w}{m_{ML}/m_{MTO}} = \frac{k_L \cdot \sigma \cdot C_{L,L} \cdot s_{LFL}}{m_{ML}/m_{MTO}} \quad (3.1)$$

The maximum landing lift coefficient  $C_{L,ML}$  is estimated as 2.4, which is a typical value for conventional aircraft featuring a high-lift system using double-slotted flaps and no leading edge high-lift devices (see **Dubs 1954**). The relative air density  $\sigma$  in the actual case is 1 as all investigations are performed for sea level conditions. The fraction of maximum landing to maximum take-off mass  $m_{ML}/m_{MTO}$  is 0.97 based on the original ATR 72's maximum landing and maximum take-off masses. The landing factor  $k_L$  is estimated as 0.137 kg/m<sup>3</sup> based on the investigations of the ATR 72 presented in **Niță 2008**.

These input values lead to the following maximum wing loading of

$$\frac{m_{MTO}}{S_w} \leq 362 \frac{\text{kg}}{\text{m}^2} \quad (3.2)$$

## Take-Off Field Length

The take-off field length requirement delivers a minimum relation of power-to-mass ratio to wing loading. This relation is described by the slope  $a$  of the line of the take-off field length requirement in the matching chart. In case of propeller aircraft the propeller efficiency has to be taken into account, see Equation 3.3.

$$a = \frac{k_{TO} \cdot V_2 \cdot g}{s_{TOFL} \cdot \sigma \cdot C_{L,TO} \cdot \eta_{P,TO} \cdot \sqrt{2}} \quad (3.3)$$

Inside PreSTo an empirical propeller efficiency model is used to express the propeller efficiency  $\eta_p$ , which is needed for the preliminary sizing of propeller-driven aircraft. This model is based on propeller efficiency curves given in **Markwardt 1998**. The given curves were transformed into Equation 3.4 in the student project **Wolf 2009** which was supervised by the author of this report.

$$\eta_p = (0.9001 - 0.0002L) \cdot \left(1 - e^{-(0.134L - 0.3008)V}\right) \quad (3.4)$$

It can be seen that the propeller efficiency is expressed as function of the airspeed  $V$  and the so-called propeller disc loading  $L$  which is defined as

$$L = \frac{P}{\sigma \cdot \rho_0 \cdot S_D} \quad (3.5)$$

The corresponding input units for the empirical Equation 3.4 are kW/m for the propeller disc loading and m/s for the airspeed  $V$ . In Equation 3.5  $S_D$  is the propeller disc area. Figure 3.1 shows plots of the propeller efficiency development over airspeed for different propeller disc loadings. The correlations between the given curves and the functional values are of good accuracy; the average lie within a range of 0.3 to 1.55 percent.



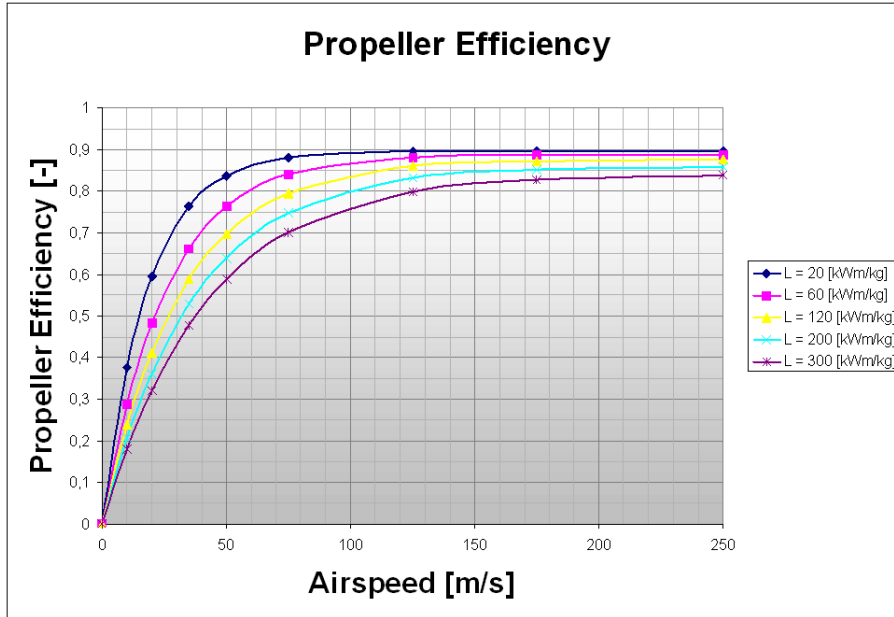

**Figure 3.1** Propeller Efficiency Versus Airspeed and Propeller Disc Loading

The still missing parameters for the determination of slope  $a$  are the lift coefficient in take-off configuration  $C_{L,TO}$ , the take-off safety speed  $V_2$  and the statistical take-off correlation parameter  $k_{TO}$ .  $C_{L,TO}$  is estimated (based on **Dubs 1954** and **Niță 2008**) as 2.1.  $V_2$  is calculated as

$$V_2 = 1.2 \cdot \frac{k_{APP} \cdot \sqrt{S_{LFL}}}{1.3} \cdot \sqrt{\frac{C_{L,L}}{C_{L,TO}}} \quad (3.6)$$

The correlation factor  $k_{TO}$  of the ATR 72 is taken from **Niță 2008** as  $k_{TO} = 2.25 \text{ m}^3/\text{kg}$ . For the maximum wing loading defined by the landing field length requirement this leads to a required power-to-mass ratio of

$$\begin{aligned} \frac{P_{TO}}{m_{MTO}} &\geq a \cdot \frac{m_{MTO}}{S_W} \\ &\geq 0.514 \frac{\text{kg}}{\text{m}^3} \cdot \frac{m_{MTO}}{S_W} \end{aligned} \quad (3.7)$$

It follows:

$$\frac{P_{TO}}{m_{MTO}} \geq 186 \frac{\text{W}}{\text{kg}} \quad (3.8)$$

## Second Segment Climb Gradient

The second segment is defined as the flight segment beginning after the complete retraction of the landing gear and ending at an altitude of 400 ft GND. During this segment the certification documents CS-25 and FAR Part 25 require a minimum climb gradient with one engine inoperative (OEI)  $\sin(\gamma_{2nd})$  of 2.4 percent for twin-engine aircraft. The second segment climb gradient requirement delivers a minimum value for the power-to-mass ratio. It is calculated according to Equation 3.9.

$$\frac{P_{TO}}{m_{MTO}} = \frac{n_E}{n_E - 1} \cdot \left( \frac{1}{E_{TO}} + \sin(\gamma_{2nd}) \right) \cdot \frac{V_2 g}{\eta_{P,2nd}} \quad (3.9)$$

In this equation the glide ratio is determined by Equation 3.10:

$$E = \frac{L}{D} = \frac{C_L}{C_D} = \frac{C_L}{C_{D,P} + \frac{C_L^2}{\pi \cdot A \cdot e}} \quad (3.10)$$

The required parasite drag coefficient  $C_{D,P}$  as well as the Oswald efficiency factor  $e$  are estimated using typical values of civil transport aircraft given in **Scholz 2010b**. This leads to a  $C_{D,P}$  of 0.038 and  $e = 0.7$ . For the aspect ratio  $A$  the original ATR 72's value of  $A = 12$  is used. It follows a glide ratio in take-off condition of  $E_{TO} = 12.3$ . The propeller efficiency during the second segment  $\eta_{P,2nd}$  is calculated as 0.698. The required power-to-mass ratio results as

$$\left( \frac{P_{TO}}{m_{MTO}} \right)_{2nd} \geq 157 \frac{\text{W}}{\text{kg}} \quad (3.11)$$

## Missed Approach Climb Gradient

The missed approach climb gradient requirement is calculated similarly to the second segment climb gradient requirement and also delivers a minimum value for the power-to-mass ratio. The differences to the second segment climb gradient requirement lie in a different aircraft configuration, a lower aircraft mass and a lower required climb gradient  $\sin(\gamma_{MAPP})$  of 2.1 percent OEI. In case of the missed approach the flaps are regarded as fully extended and, for certification according to FAR Part 25, the landing gear is extended, which produces additional drag. In this configuration the aircraft's aerodynamic performance (glide ratio) is worse than after take-off. On the other hand not the full maximum take-off mass has to be accounted for but only the maximum landing mass. In consequence, Equation 3.9 changes to Equation 3.12:

$$\frac{P_{TO}}{m_{MTO}} = \frac{n_E}{n_E - 1} \cdot \left( \frac{1}{E_{MAPP}} + \sin(\gamma_{MAPP}) \right) \cdot \frac{m_{ML}}{m_{MTO}} \cdot \frac{V_2 g}{\eta_{P,MAPP}} \quad (3.12)$$

Using standard data for parasite drag prediction from **Scholz 2010b** gives a  $C_{D,P}$  of 0.051; the values of Oswald efficiency factor and aspect ratio do not change to the second segment climb gradient requirement. The glide ratio during missed approach decreases to  $E_L = 11.1$ , which causes a minimum power-to-mass ratio of

$$\left( \frac{P_{TO}}{m_{MTO}} \right)_{MAPP} \geq 159 \frac{W}{kg} \quad (3.13)$$

### Cruise Flight

The cruise flight requirement delivers a minimum relation of power-to-mass ratio to wing loading for different altitudes at the required cruise Mach number. For this purpose the values of maximum wing loading and minimum power-to-mass ratio at the actual altitude  $h$  are calculated using Equations 3.14 and 3.15.

$$\frac{m_{MTO}}{S_W}(h) = \frac{C_{L,CR} \cdot M_{CR}^2 \cdot \kappa_{AIR} \cdot p(h)}{2g} \quad (3.14)$$

$$\frac{P_{TO}}{m_{MTO}}(h) = \frac{M_{CR} \cdot a(h) \cdot g}{\frac{P_{CR}}{P_{TO}} \cdot E_{CR} \cdot \eta_{P,CR}} \quad (3.15)$$

In Equation 3.15 the power decrease with rising altitude has to be taken into account. The model for this decrease is based on the Pratt & Whitney PW120 turboprop family, which is used on the ATR 72. Its development is presented in **Niță 2008**. Equation 3.16 shows the derived correlation.

$$\frac{P_{CR}}{P_{TO}} = 1.883 \cdot M_{CR} \cdot \sigma^{0.929} \quad (3.16)$$

Moreover, the glide ratio in cruise flight configuration is needed. This value is found using Equation 3.17.

$$E_{CR} = \frac{2E_{MAX}}{\frac{C_{L,CR}}{C_{L,MD}} + \frac{1}{\frac{C_{L,CR}}{C_{L,MD}}}}, \text{ in which} \quad (3.17)$$

$$\frac{C_{L,CR}}{C_{L,MD}} = \frac{1}{\left(\frac{V_{CR}}{V_{MD}}\right)^2}. \quad (3.18)$$

The value of cruise speed  $V_{CR}$  to minimum drag speed  $V_{MD}$  was chosen as 1.15, which is a realistic value, as aircraft are operated at higher speeds than their minimum speed for economic reasons. The maximum glide ratio  $E_{MAX}$  is found using a statistical correlation of the aspect ratio  $A$ , the ratio of wetted area to wing area  $S_{WET}/S_W$  and a correlation factor  $k_E$ :

$$E_{MAX} = k_E \cdot \sqrt{\frac{A}{S_{WET}/S_W}} \quad (3.19)$$

The chosen input values for  $k_E$  and  $S_{WET}/S_W$  are  $k_E = 12.918$  and  $S_{WET}/S_W = 6.1$  (**Raymer 1999, Scholz 2005, Niță 2008**). The resulting maximum glide ratio is  $E_{MAX} = 18.1$ . From this maximum value follows a glide ratio during cruise flight of  $E_{CR} = 17.4$ .

A following iteration of cruise speed, cruise altitude and propeller efficiency delivers the cruise flight conditions in terms of speed and altitude and leads to the matching chart and aircraft design point. The iteration starts with an estimated cruise altitude of 7,000 m and is improved in three iteration loops. For this purpose, first, the cruise speed is calculated from the local speed of sound and the cruise Mach number requirement.

$$V_{CR} = a(h) \cdot M_{CR} \quad (3.20)$$

This enables a new determination of the ratio of cruise power to maximum take-off power  $P_{CR}/P_{TO}$  (Equation 3.16), the propeller disc loading  $L$  (Equation 3.5) and a new propeller efficiency  $\eta_p$  (Equation 3.4). Investigations have shown that the cruise speed iteration converges very fast and that three iteration steps deliver sufficiently accurate results. In the present case, the last iteration step changes the cruise speed by only 0.04 percent. The cruise flight conditions result as  $h_{CR} = 7668$  m and  $V_{CR} = 138$  m/s (269 kt).

## Matching Charts and Aircraft Design Points

The results of the five recently treated TLARs lead to the matching charts presented in Figure 3.2. The determined aircraft design point in terms of wing loading and power-to-mass ratio results as.

- Wing loading: 
$$\frac{m_{MTO}}{S_w} = 362 \frac{\text{kg}}{\text{m}^2} \quad \text{and} \quad (3.21)$$

- Power-to-mass ratio: 
$$\frac{P_{TO}}{m_{MTO}} = 186 \frac{\text{W}}{\text{kg}} \quad . \quad (3.22)$$

It becomes apparent that the original ATR 72's aircraft design point is met in good accuracy ( $(m_{MTO}/S_w)_{ATR72} = 361 \text{ kg/m}^2$  ;  $(P_{TO}/m_{MTO})_{ATR72} = 186 \text{ W/kg}$  ).

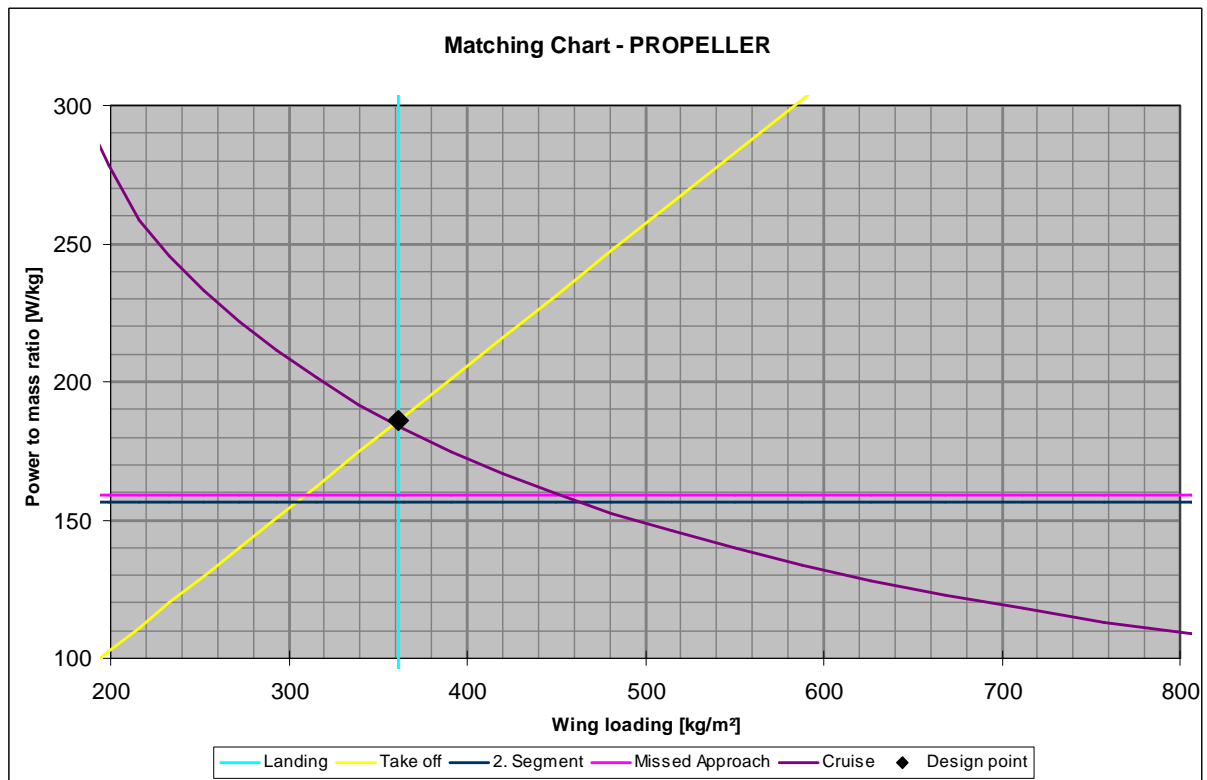

**Figure 3.2** Preliminary Sizing Matching Chart

### 3.1.2 Sizing

From the aircraft design point determined in the previous section the fuel requirement, masses, engine power and wing area are calculated in the following. In first instance, the fuel fractions of the individual flight segments are determined. A flight segment fuel fraction describes the ratio of aircraft mass after a flight segment to the aircraft mass before the flight segment.

The cruise flight fuel fraction  $M_{FF,CR}$  is calculated from the Breguet range equation using the required flight range  $R$ , the propeller efficiency  $\eta_{P,CR}$ , the glide ratio  $E_{CR}$ , the (power-) specific fuel consumption of the engines and the gravitational acceleration  $g$  :

$$R = \frac{\eta_{P,CR} \cdot E_{CR}}{cg} \ln\left(\frac{m_1}{m_2}\right) . \quad (3.23)$$

As in this step the exact distances of take-off, climb, descent and landing are not known the full required range is regarded as cruise flight distance. The power-specific fuel consumption for the kerosene version is taken from **Niță 2008** as 198 mg/Wh. It follows a cruise flight fuel fraction of  $M_{FF,CR} = 0.967$  .

Next, the fractions for the fuel reserves are calculated. In case of the ATR 72 these account for 87 NM distance to an alternate airport and 45 min loiter time at continued cruise. Extra fuel according to FAR Part 121 does not have to be taken into account as this range does not belong to the flight category ‘International’. The Breguet equation with respect to endurance is given by

$$t = \frac{\eta_{P,CR} \cdot E_{CR}}{cgV_{CR}} \ln\left(\frac{m_1}{m_2}\right) . \quad (3.24)$$

The resulting fuel fractions for the reserves and loiter time are  $M_{FF,RES} = 0.994$  and  $M_{FF,LOITER} = 0.987$  .

The fuel fractions for the missing flight segments “Engine start”, “Taxi”, “Take-off”, “Climb”, “Descent” and “Landing” are not calculated individually but estimated based on data of existing aircraft published in **Roskam 1990** with one modification: The fuel fractions for the flight segment “Descent” is set to 1. As mentioned earlier, the cruise flight segment comprises the complete required flight range, and using fuel fractions smaller than 1 would account for these flight segments twice. In case of take-off and climb this is acceptable due to the increased power setting and fuel consumption. For the descent, however, where the power setting is significantly reduced compared to cruise flight this would cause too high values of

fuel consumption. The resulting fuel fractions are collected in Table 3.2. This table also includes the resulting values for a complete standard flight, all reserves, the total fuel requirement and the total mission fuel fraction.

**Table 3.2** Flight Segment Fuel Fractions

Flight Segment	Symbol	Value
Cruise	$M_{FF,CR}$	0.967
Reserves (distance to alternate airport)	$M_{FF,ALT}$	0.994
Loiter time	$M_{FF,LOITER}$	0.987
Engine start	$M_{FF,E-START}$	0.990
Taxi	$M_{FF,TAXI}$	0.995
Take-off	$M_{FF,TO}$	0.995
Climb	$M_{FF,CLB}$	0.985
Descent	$M_{FF,DES}$	1
Landing	$M_{FF,L}$	0.995
Standard flight	$M_{FF,STD}$	0.943
All reserves	$M_{FF,RES}$	0.966
Total	$M_{FF}$	0.911
Mission fuel fraction	$\frac{m_F}{m_{MTO}}$	0.089

### Aircraft Masses, Wing Area and Engine Power

The fuel fraction values enable the final calculation of the preliminary aircraft parameters such as maximum take-off mass, wing area, required fuel volume and required engine power. All determined results are collected in Table 3.5 .

The maximum take-off mass is calculated using Equation 3.25.

$$m_{MTO} = \frac{m_{PL}}{1 - \frac{m_F}{m_{MTO}} - \frac{m_{OE}}{m_{MTO}}} \quad (3.25)$$

In this equation the ratio of operating empty mass to maximum take-off mass is still missing. This value is determined based on real ATR 72 data as  $m_{OE}/m_{MTO} = 0.541$ . The mass of one passenger including baggage is estimated as 93 kg.

The maximum take-off mass results as  $m_{MTO} = 21.9$  t. Consequently, the maximum landing mass and operating empty mass result as  $m_{ML} = 21.2$  t and  $m_{OE} = 11.8$  t. Moreover, the aircraft requires a fuel mass of  $m_{F,REQ} = 2.2$  t ( $V_{F,REQ} = 2.8$  m<sup>3</sup>). A feasibility check whether

the maximum landing mass is larger than the sum of operating empty mass, payload and reserve fuel mass (Equation 3.26) is positive:

$$m_{ML} \geq m_{OE} + m_{PL} + m_{F,RES} \quad . \quad (3.26)$$

The wing area is  $S_W = 60.5 \text{ m}^2$ , and the aircraft requires a maximum take-off power rating of  $P_{TO} = 4068 \text{ kW}$  or  $P_{TO,E} = 2034 \text{ kW}$  per engine.

### Preliminary Sizing Results

The following Tables 3.3 to 3.5 list the determined results of the aircraft preliminary sizing process. Figure 3.3 shows the respective PreSTo section including a comparison to the original values of the reference aircraft.

**Table 3.3** Preliminary Sizing – Cruise Flight Conditions

Parameter	Symbol	Unit	Value
Cruise glide ratio	$E_{CR}$	-	17.4
Power-specific fuel consumption	$c$	mg/(Wh)	198
Cruise speed	$V_{CR}$	m/s (kt)	138 (269)
Cruise altitude	$h_{CR}$	m (ft)	7,668 (25,160)

**Table 3.4** Preliminary Sizing – Aircraft Design Points

Parameter	Symbol	Unit	Value	Original ATR 72
Wing loading	$\frac{m_{MTO}}{S_W}$	kg/m <sup>2</sup>	362	361
Power-to-mass ratio	$\frac{P_{TO}}{m_{MTO}}$	W/kg	186	186



**Table 3.5** Preliminary Sizing – Aircraft Parameters

Parameter	Symbol	Unit	Value
Max. take-off mass	$m_{MTO}$	t	21.9
Max. landing mass	$m_{ML}$	t	21.2
Operating empty mass	$m_{OE}$	t	11.8
Payload	$m_{PL}$	t	8.1
Max. zero-fuel mass	$m_{MZF}$	t	19.9
Standard flight fuel mass	$m_{F,STD}$	t	1.95
Reserves fuel mass	$m_{F,RES}$	t	0.74
Required fuel mass	$m_{F,REQ}$	t	2.24
Required fuel volume	$V_{F,REQ}$	m <sup>3</sup>	2.8
Wing area	$S_W$	m <sup>2</sup>	60.5
Take-off power	$P_{TO}$	kW	4068
Engine take-off power	$P_{TO,E}$	kW	2034

Aircraft data				Comparative data			
Max. take-off mass	$m_{MTO}$	21875 [kg]	↔	Max. Take-off mass	$m_{MTO}$	22000 [kg]	
Max. landing mass	$m_{ML}$	21219 [kg]	↔	Max. landing mass	$m_{ML}$	21350 [kg]	
Operating empty mass	$m_{OE}$	11835 [kg]	↔	Operating empty mass	$m_{OE}$	11907 [kg]	
Payload	$m_{PL}$	8096 [kg]					
Max. zero-fuel mass	$m_{MZF}$	19931 [kg]					
Mission fuel fraction, standard flight	$m_F$	1945 [kg]	↔	Mission fuel fraction, standard flight	$m_F$	2000 [kg]	
Fuel mass, required	$m_{F,req}$	2243 [kg]					
Fuel mass, all reserves	$m_{F,res}$	741 [kg]					
Fuel volume, required	$V_{F,req}$	2,80 [m <sup>3</sup> ]					
Wing area	$S_W$	60,5 [m <sup>2</sup> ]	↔	Wing area	$S_W$	61 [m <sup>2</sup> ]	
Take-off power	$P_{S,TO}$	4068 [kW]					
Take-off power of ONE engine	$P_{S,TO/nE}$	2034 [kW]	↔	T-O power of ONE engine	$P_{S,TO} / nE$	2051 [kW]	
Number of engines	$nE$	2 [-]					

**Figure 3.3** Presentation of the Preliminary Sizing Results in PreSTo

## 3.2 Conceptual Design of the Fuselage

This section describes the work steps inside PreSTo to achieve a principle geometric description of the aircraft fuselage. ...

### Configuration of Classes

The first step during fuselage design is to define seat classes. PreSTo offers up to three different classes: Economy Class (YC), Business Class (BC) and First Class (FC). In this work, all 72 passenger seats are treated as Economy Class seats. These seats shall be positioned in four seats abreast rows with a single middle aisle.

### Cross Section

For fuselage cross section definition the seat and passenger dimensions have to be entered to construct a cabin cross section around a seat row. As input values typical data for aircraft seats and a typical so-called “95 % American Male” are used (**Scholz 2010b**, **Montarnal 2010**, see Table 3.6). Based on the original ATR 72 a lower deck compartment is not defined. Details on the definition of a lower deck compartment can be found in **Seeckt 2008** and **Montarnal 2010**.

**Table 3.6** Passenger, Passenger Seat and Cabin Aisle Dimensions

Parameter	Unit	Value
Passenger mid shoulder height, sitting	m	0.7
Shoulder breadth	m	0.53
Eye height, sitting	m	0.87
Head-to-wall clearance	m	0.06
Shoulder-to-wall clearance	m	0.04
Cushion width	inch	18
Cushion height position	m	0.42
Cushion thickness	m	0.14
Armrest width	inch	2
Backrest height	m	0.59
Seat length	inch	25
Aisle width	inch	20
Aisle height	inch	79

In combination with a height-to-width ratio of the fuselage of 1 the given values lead to the following fuselage cross section dimensions and sketch (Figure 3.4).

**Table 3.7** Fuselage Cross Section Dimensions

Parameter	Unit	Value
Ratio of cabin height to cabin width	-	1
Floor lowering from horizontal symmetry	m	0.72
Fuselage inner height	m	2.76
Fuselage inner width	m	2.76
Fuselage thickness	m	0.1
Fuselage outer diameter	m	2.97
Floor thickness	m	0.1

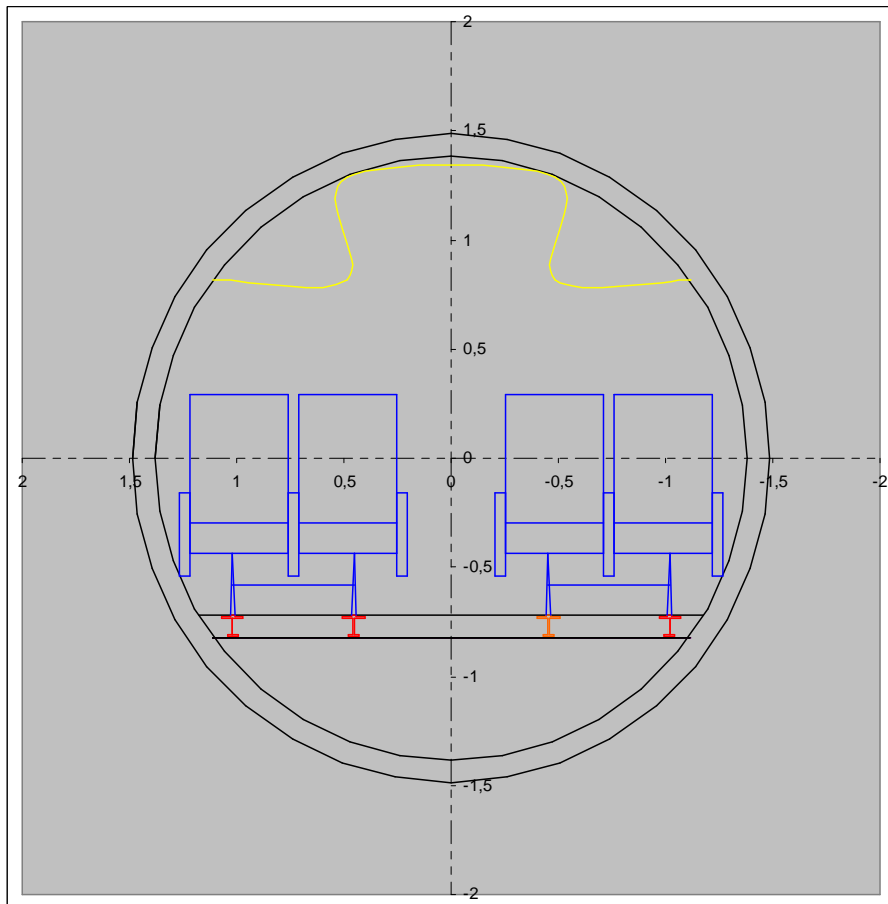
**Figure 3.4** Fuselage Cross Section Sketch

### Cabin Floor Plan

For the definition of the cabin floor plan the required amount of passenger seats are positioned in twin-seat rows plus additional space for exits and cabin monuments such as galleys and lavatories. As in the previous sections the original ATR 72 acts as baseline design and example for this work step. Figure 3.5 shows a typical ATR 72 floor plan in 72 passengers configuration. As PreSTo only offers the two cabin monument types “Lavatory” and “Galley” the storage compartment inside the original ATR 72 are represented by additional galleys. Figure 3.6 shows the way of positioning seat rows, exits lavatories and galleys inside PreSTo

using drop-down menus. Figure 3.7 shows the floor plan of the tentative regional aircraft as re-modeled using PreSTo.

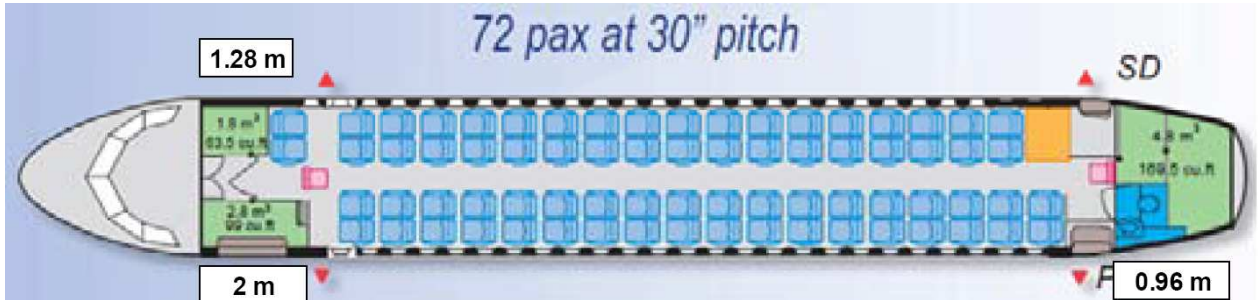

Figure 3.5 Original ATR 72 Cabin Floor Plan

Rows configuration						
Effective row	Monuments			Class	Exit	Atten- dant Seat
	Left	Center	Right			
	Galley YC	None	Galley YC		None	NO
1	None	None	None	3	Type C	NO
2	None	None	None	3	None	NO
3	None	None	None	3	None	NO
4	None	None	None	3	None	NO
5	None	None	None	3	None	NO
6	None	None	None	3	None	NO
7	None	None	None	3	None	NO
8	None	None	None	3	None	NO
9	None	None	None	3	None	NO
10	None	None	None	3	None	NO
11	None	None	None	3	None	NO
12	None	None	None	3	None	NO
13	None	None	None	3	None	NO
14	None	None	None	3	None	NO
15	None	None	None	3	None	NO
16	None	None	None	3	None	NO
17	None	None	None	3	None	NO
18	None	None	None	3	None	NO
	None	None	None		Type A	NO
	Lavatory	None	Galley YC		None	NO
	None	Galley YC	None		None	NO

Figure 3.6 Cabin Floor Plan Definition Inside PreSTo

### Fuselage Outer Contour

The outer contour of the fuselage is defined by the fuselage cross section diameter plus a nose and a tail cone. The sharpness ratios of these cones are defined by their length-to-diameter ratios. The cones are x-wise positioned by offset values between the most forward (resp. aft) cabin installation and the beginning of the individual cone. Figure 3.7 shows the final definition of the cabin floor plan and the fuselage outer contour. Table 3.8 collects the related input values. The total fuselage length results as 27.35 m.

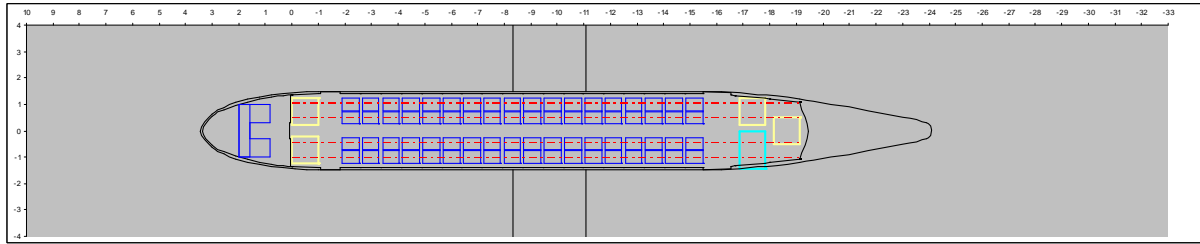

**Figure 3.7** PreSTo Cabin Floor Plan and Fuselage Outer Contour

**Table 3.8** Fuselage Outer Contour Definition

Parameter	Unit	Value
Nose length-to-diameter ratio	-	1.5
Nose offset	m	1
Tail length-to-diameter ratio	-	2.6
Tail offset-to-diameter ratio	-	1
Cabin length	m	19.14
Total fuselage length	m	27.35

### 3.3 Conceptual Design of the Wing

The wing parameters area, aspect ratio and span have already been defined during the preliminary sizing of the aircraft. There, also the vertical wing position has been determined; in this example “High Wing” has been selected. In this section dealing with the worksheet “Wing” a refined geometric description is prepared. PreSTo offers the possibility to include one kink in the wing top view. Asymmetric wing shapes about the x-z-plane cannot be defined.

#### Sweep angle

As reference chord wise position the 25%-line is used. The wing sweep is defined by the user for both wing segments inside and outside the kink position. For user guidance sweep suggestions from literature are presented with respect to the cruise Mach number (see e.g. Figure 3.8). Moreover, this PreSTo section offers two automated design options: a) to create a straight leading edge from wing root to tip and b) to design a perpendicular intersection of the wing trailing edge and the fuselage. Based on the original ATR 72 the inner and outer sweep angles are set to  $0^\circ$  and  $1^\circ$ .

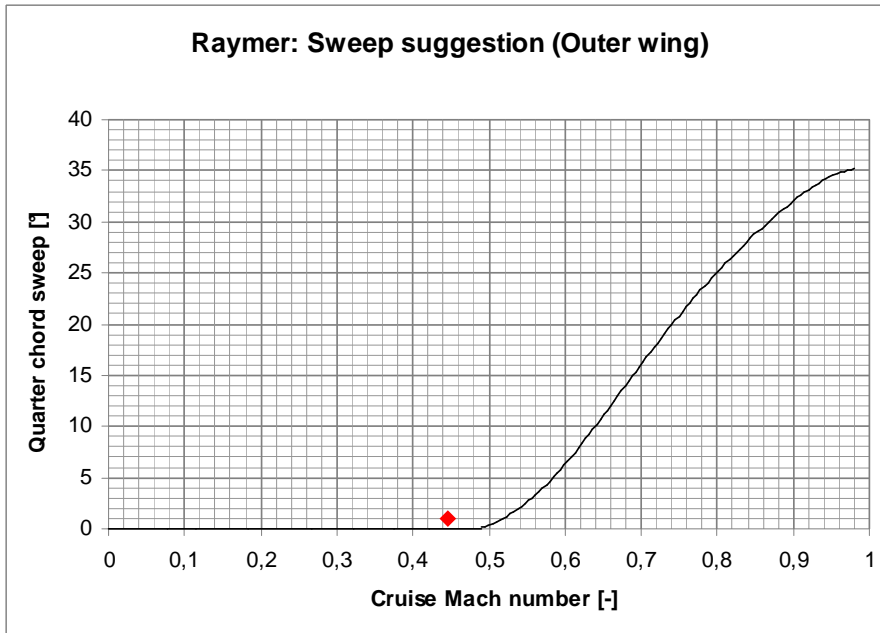

Figure 3.8 Wing Sweep Suggestion

### Lift and chord distribution

In the next step, the wing taper ratio and the parametric kink position are defined. Again, some user guidance is provided based on aircraft design literature and in relation to the previously defined wing sweep angle. The wing taper ratio is determined as 0.419 based on the real ATR 72. This value lies between the suggestions of **Howe 2005** and **Torenbeek 1988** (see Figure 3.9). The spanwise kink position is set to 0.39; for this parameter no suggestions from literature are given.

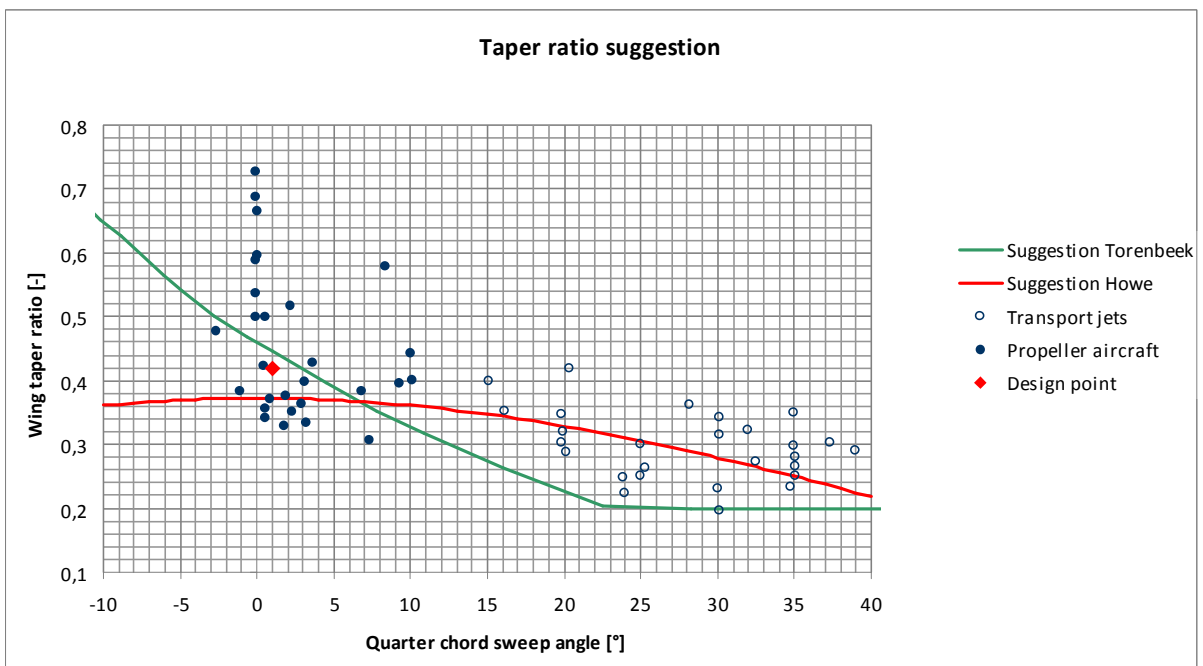

Figure 3.9 Wing Taper Ratio Suggestion

At the end of this section the principle wing planform is already defined (see Figure 3.12). The baseline wing geometry parameters are collected in Table 3.9.

**Table 3.9** Wing Geometry Parameters

Parameter	Unit	Value
Root chord	m	2.73
Kink chord	m	2.73
Tip chord	m	1.14
Spanwise kink position (from symmetry axis)	m	5.25
Aspect ratio inner trapezoid	-	2.76
Aspect ratio outer trapezoid	-	8.49
Wing area inside fuselage	m <sup>2</sup>	8.1
Wing area inner trapezoid	m <sup>2</sup>	20.56
Wing area outer trapezoid	m <sup>2</sup>	31.81

### Dihedral angle, wing twist and incidence angle

The dihedral angle is set to 0° as for the original ATR 72. As wing twist -3° (from root to tip) is selected. This value has no influence on further calculations inside PreSTo but is important for further investigations with e.g. CEASIOM (see Section 4). Figure 3.10 shows the sketch of the aircraft in front view.

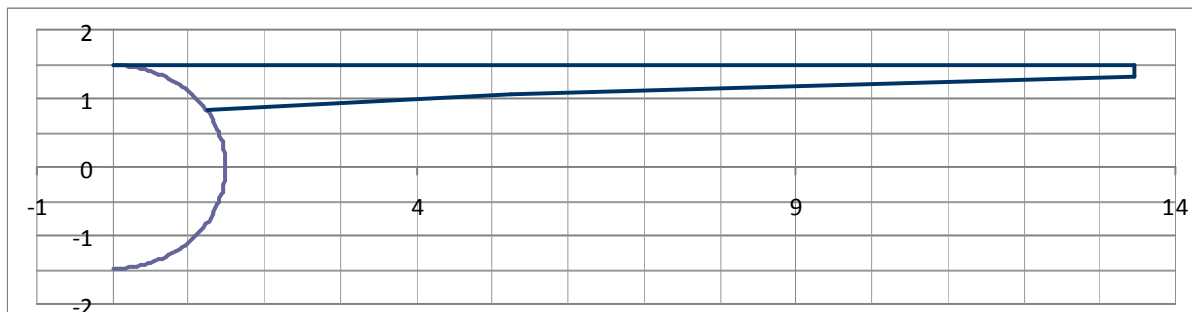

**Figure 3.10** Front View Sketch

### Airfoil selection

The wing airfoil (one for the whole wing) is selected from an airfoil catalogue. At the time of writing this report this catalogue encompasses 122 airfoils. Based on the real ATR 72 the profile “NACA 23018” is selected (see Figure 3.11). The geometric description of the original ATR 72 airfoil is not disclosed.

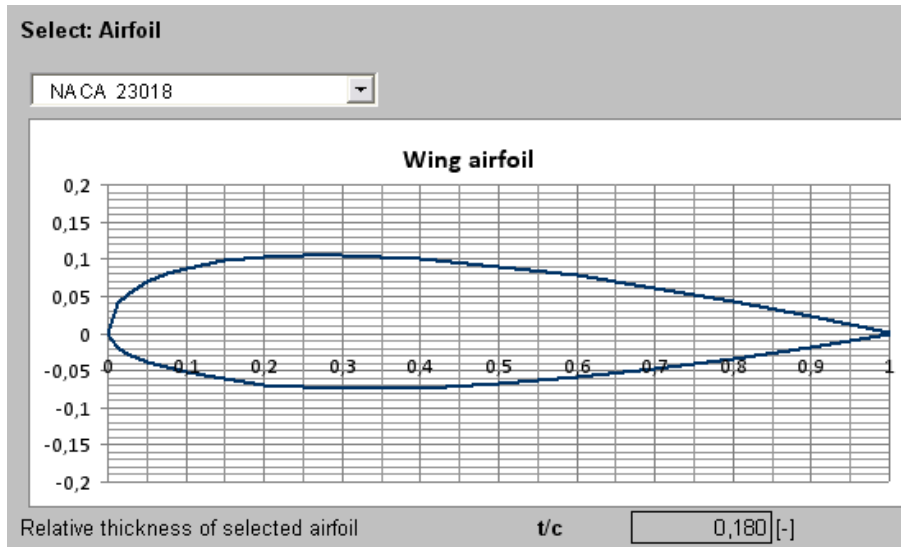

**Figure 3.11** Wing Airfoil Selection

## Ailerons

For aileron size and position suggestions are given to the user based on data presented in **Howe 2005**. However, for this project values are selected that are based on the real ATR 72. PreSTo offers the design of additional high-speed ailerons as used on e.g. the Airbus A310. This type of ailerons is not used on the original ATR 72 and in this project. Table 3.10 compares the selected data to the suggestions. Figure 3.12 shows the resulting wing sketch including the aileron.

**Table 3.10** Aileron Data and PreSTo Suggestions

Parameter	Unit	Suggestion based on <b>Howe 2005</b>	Original ATR 72 Value
Total aileron area	m <sup>2</sup>	3.51	3.75
Aileron midpoint span position	-	0.4	0.435
Relative aileron span	-	0.33	0.25
Relative aileron chord	-	0.25	0.35

## Fuel volume estimation

Based on the prepared wing sketch and airfoil selection a first estimation of the fuel tank volume is performed. For this estimation it is assumed that 54 percent of the wing chord may be used for fuel storage. Moreover, the complete wing from centerline to wing tip is included in this estimation. It follows a total fuel tank volume of about 8.7 m<sup>3</sup>, which, at a fuel density of 0.8 kg/dm<sup>3</sup> corresponds to 7 t of fuel. The original maximum fuel mass of the ATR 72 is smaller (5 t) because the fuel tanks do not extend over the complete wing span.



## High-Lift System

PreSTo offers the design of trailing and leading edge high-lift devices. For the leading edge the user may select between leading edge flaps and slats. No leading edge high-lift device may be selected as well. This is also the case for the re-design of the ATR 72, as the original aircraft features no leading edge high-lift devices.

List of selectable trailing edge high-lift devices comprises the flap types Plain Flap, Split Flap, Slotted Flap, Slotted Fowler Flap and Double Slotted Flap. The ATR 72 features double slotted flaps. The inner flaps extend from short outside the fuselage-wing intersection to the wing kink and the outer flaps from the kink to the inner edge of the aileron. Parametrically expressed this means relative spanwise positions of 0.11, 0.39 and 0.74. The relative flap chord is 0.3 (see Figure 3.12).

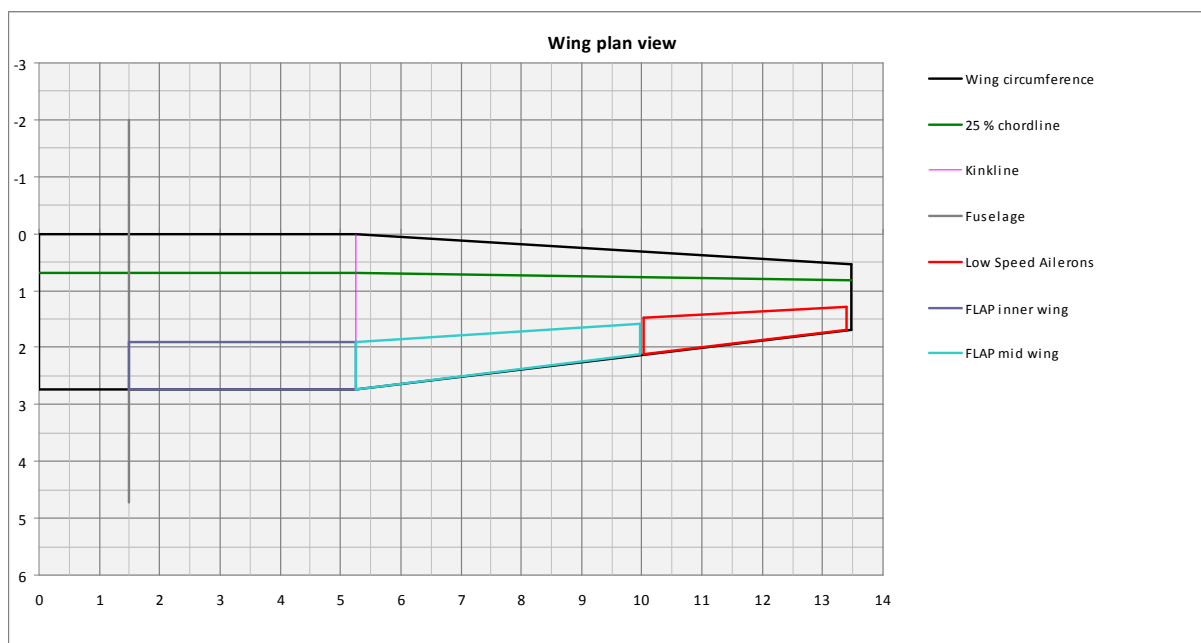

**Figure 3.12** Wing Planform Including Aileron and Flaps

## 3.4 Conceptual Design of the Tailplane

The ATR 72 is the stretched version of the ATR 42 which features the same tailplane. This causes that the tailplane of the ATR 72 is principally oversized – due to the longer fuselage and consequently longer tailplane lever arm, the sizes of the vertical and horizontal tail could have been reduced. However, because of a reduced production effort both aircraft version feature the same tailplane. For this project that means that the suggestions given to the user for tailplane design do not correspond to the data of the original ATR 72. As this re-design project is geared to the ATR 72 this aircraft's data are used. PreSTo offer three types of

tailplane configuration: Conventional, T-Tail and H-Tail. Based on the original ATR 72 the T-Tail configuration is selected.

### Horizontal Tail and Elevator

The values of the ATR 72 for the horizontal tail dimensions correspond well to the PreSTo suggestions based on **Scholz 2005**, **Raymer 1999** and **Roskam 1990**. The selected values as well as the PreSTo suggestions are listed in Table 3.11. Figure 3.13 shows the sketch of the horizontal tail planform and elevator.

**Table 3.11** Horizontal Tail Data and PreSTo Suggestions (based on **Scholz 2005**, **Raymer 1999** and **Roskam 1990**)

Parameter	Unit	PreSTo Suggestion	Selected Value
Aspect ratio	-	6	6
Sweep angle	°	6	6
Taper ratio	-	0.39 ... 1.0	0.39
Dihedral angle	°	0 ... 12	0
Incidence angle	°	0 ... -3	-2
Relative elevator chord	-	0.25	0.25
Elevator inner edge position	-	0.05	0.05
Elevator outer edge position	-	0.45	0.45

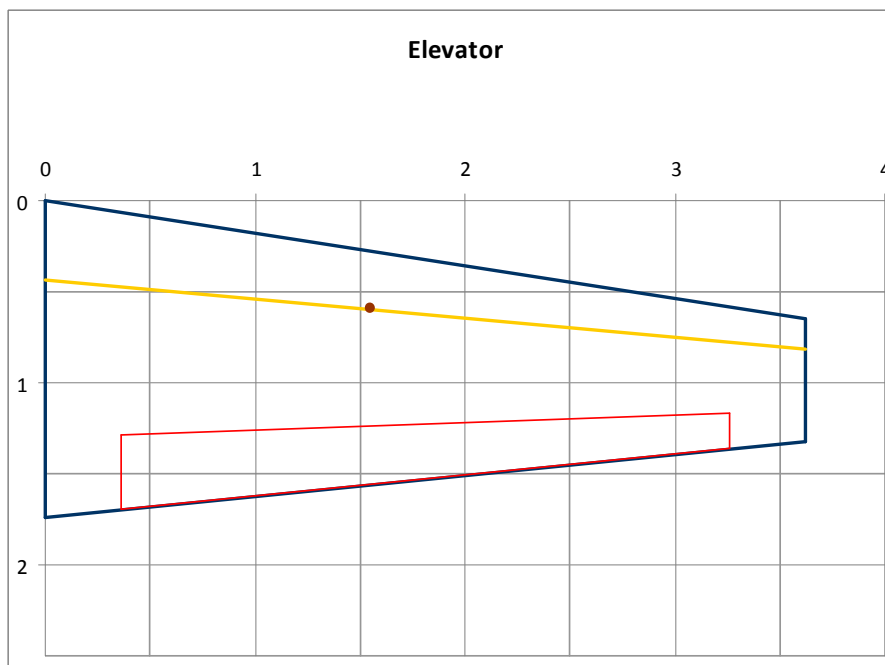

**Figure 3.13** Horizontal Tail Planform Including Elevator

As the horizontal tail airfoil the NACA 0010 is selected (see Figure 3.14).

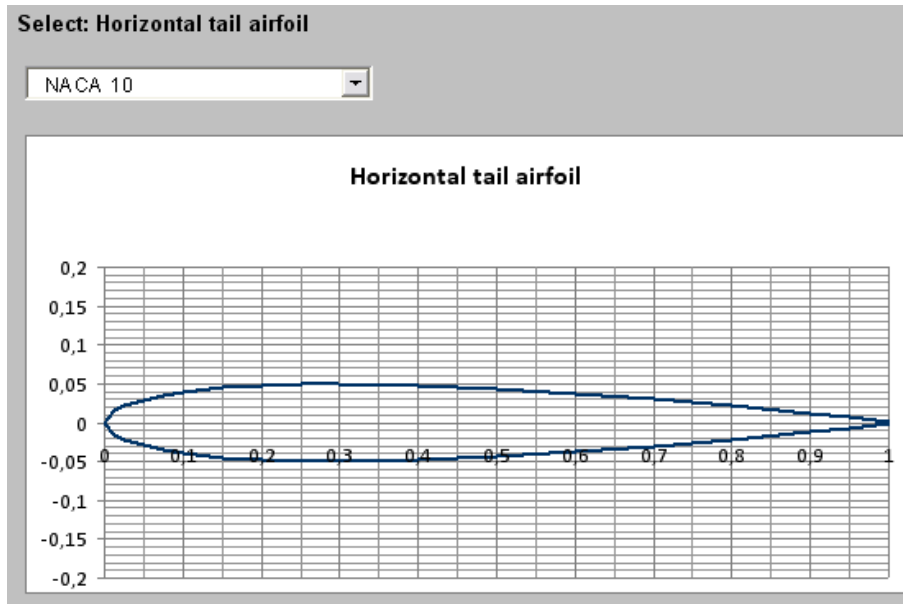

**Figure 3.14** Horizontal Tail Airfoil Selection

### Vertical Tail and Rudder

Also the data of the vertical tail and rudder correspond well to the suggestions made by PreSTo based on aircraft design literature (**Raymer 1999** and **Roskam 1990**). The suggestion and selected values for vertical tail and rudder definition are compared in Table 3.12. Figure 3.15 shows a sketch of the vertical tail including the rudder. As for the horizontal tail the NACA 0010 airfoil was selected for the vertical tail.

**Table 3.12** Vertical Tail Data and PreSTo Suggestions (based on **Raymer 1999** and **Roskam 1990**)

Parameter	Unit	PreSTo Suggestion	Selected Value
Aspect ratio	-	0.8 ... 1.7	1.2
Sweep angle	°	0 ... 45	35
Taper ratio	-	0.32 ... 1	0.6
Dihedral angle	°	0	0
Incidence angle	°	90	90
Relative rudder chord	-	0.32	0.32
Rudder lower edge position	-	0.1	0.1
Rudder upper edge position	-	0.9	0.9

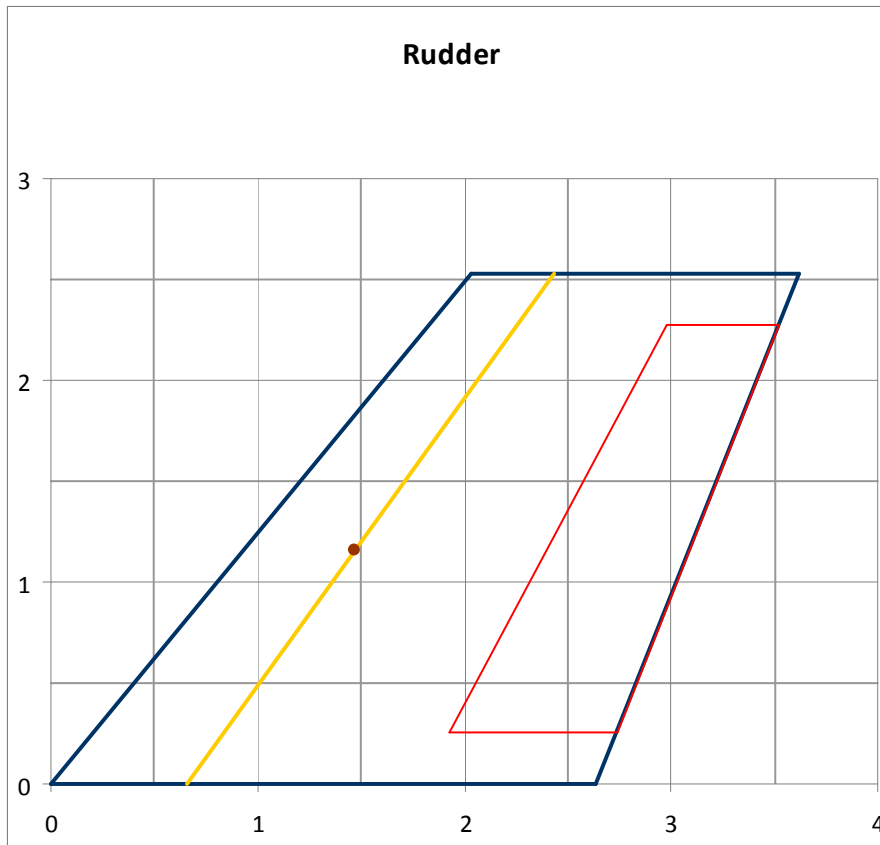

**Figure 3.15** Vertical Tail Including Rudder

## 4 Data Export to CEASIOM

The working process inside CEASIOM starts with a geometric description of the new aircraft design in the CEASIOM-module AcBuilder. Many of the required aircraft parameters such as fuselage length and wing position have already been determined inside PreSTo and can be exported to CEASIOM. As stated earlier, CEASIOM uses the xml-data format consisting of one line for each parameter including parameter name, field size and the respective value (see Figure 2.6). Inside PreSTo the required AcBuilder input data are prepared and listed in a separate Excel worksheet named “CEASIOM”. Where data is already available the PreSTo data are used, modified to fit to the AcBuilder parameter definition if required and collected in individual data lines and blocks (see Figure 4.1). Moreover, it is assured that all data use dots instead of commas as decimal separators (in case of German Excel country settings). All data are rounded to three decimals.

	A	B	C	D	E	F	G	H	I	J	K	L	M	N	O	P	Q	R	S	T	U	V
1	CEASIO Input File	<?xml version="1.0" ?>																				
2		<root xml:tb_version="3.2.1" id="1" type="struct" size="1 1">																				
3	Fuselage	<Fuselage id="1" type="struct" size="1 1">																				
4		<present id="1" type="double" size="1 1">1</present>																				
5		<omega_nose id="1" type="double" size="1 1">0</omega_nose>																				
6		<phi_nose id="1" type="double" size="1 1">0</phi_nose>																				
7	1.5	<epsilon_nose id="1" type="double" size="1 1">1.5</epsilon_nose>																				
8	2.97	<Forefuse_X_sect_vertical_diameter id="1" type="double" size="1 1">2.97</Forefuse_X_sect_vertical_diameter>																				
9	2.97	<Forefuse_X_sect_horizontal_diameter id="1" type="double" size="1 1">2.97</Forefuse_X_sect_horizontal_diameter>																				
10	0.5	<Forefuse_Xs_distortion_coefficient id="1" type="double" size="1 1">0.5</Forefuse_Xs_distortion_coefficient>																				
11		<omega_tail id="1" type="double" size="1 1">0</omega_tail>																				
12		<phi_tail id="1" type="double" size="1 1">0</phi_tail>																				
13	2.6	<epsilon_tail id="1" type="double" size="1 1">2.6</epsilon_tail>																				
14	2.97	<ARfuse_X_sect_vertical_diameter id="1" type="double" size="1 1">2.97</ARfuse_X_sect_vertical_diameter>																				
15	2.97	<ARfuse_X_sect_horizontal_diameter id="1" type="double" size="1 1">2.97</ARfuse_X_sect_horizontal_diameter>																				
16	0.5	<ARfuse_Xs_distortion_coefficient id="1" type="double" size="1 1">0.5</ARfuse_Xs_distortion_coefficient>																				
17	7.723	<Tail_length id="1" type="double" size="1 1">7.723</Tail_length>																				
18		<fraction_fore id="1" type="double" size="1 1">0</fraction_fore>																				
19		<shift_fore id="1" type="double" size="1 1">0</shift_fore>																				
20	27.353	<Total_fuselage_length id="1" type="double" size="1 1">27.353</Total_fuselage_length>																				
21		</Fuselage>																				
22	Wing1	<Wing1 id="1" type="struct" size="1 1">																				
76	Wing2	<Wing2 id="1" type="struct" size="1 1">																				
82	Horizontal_tail	<Horizontal_tail id="1" type="struct" size="1 1">																				
110	Vertical_tail	<Vertical_tail id="1" type="struct" size="1 1">																				
137	Engines, Tailbooms, Canard, Ventral fin	<Baggage id="1" type="struct" size="1 1">																				
153	Baggage	<cabin id="1" type="struct" size="1 1">																				
158	Cabin	<miscellaneous id="1" type="struct" size="1 1">																				
171	Miscellaneous	</root>																				
177																						
178																						
179	Export Data to CEASIO (AcBuilder)																					
180																						

Figure 4.1 PreSto-Worksheet "CEASIO"

Data that have not been determined by PreSto yet, such as the nose and tail cone angles of the fuselage, are filled with default values and marked in yellow to inform the user about the preliminary status of these data. Example: As the vertical wing positioning inside PreSto is performed by selecting one of the positions high-wing or low-wing, these concrete positions are translated to CEASIO as default z-position values. They are set to 0.95 for the high-wing position and 0.1 for the low-wing position (see Figures 4.2 to 4.4).

For data export a macro is started by clicking the command button "Export Data to CEASIO (AcBuilder)" that collects the actual input data in the "CEASIO" worksheet down to the cell containing the end statement </root>. Then the user defines a filename and target folder, and an xml-file is created.

## 4.1 Aircraft Modeling with AcBuilder

The CEASIO module AcBuilder consists of four input sections for the user aircraft definition:

- Geometry/Components,
- Geometry/Fuel,
- Weights & Balance and
- Technology.

The required work process for a correct aircraft definition is described in the AcBuilder startup-window:

- 1- Run Geometry => Components (Make sure flaps are present for S&C)
- 2- Run Geometry => Fuel

- 3- Run Geometry => Geometry
- 4- Run Weights & Balance => Weights & Balance
- 5- Run Weights & Balance => Centers of gravity
- 6- Run again Weights & Balance => Weights & Balance (check the automatic generated values)
- 7- Run Technology => Technology
- 8- Export XML
- 9- Close

Note: The investigations of CEASIOM underlying this report as well as previous studies with CEASIOM have shown that it is very important for the user to follow the specified workflow. Changes in the order of the executed modules or missing modules cause inconsistent data in the created xml-file. Such errors inhibit the further use of the aircraft model in the following CEASIOM modules, and the aircraft definition has to be repeated.

#### **4.1.1 Data Import from PreSTo**

Inside the “Geometry/Components” section the user may define up to ten different aircraft components:

- Fuselage,
- Wing 1,
- Wing 2,
- Horizontal tail,
- Vertical tail,
- Engines 1,
- Engines 2,
- Tailbooms,
- Canard and
- Ventral fin.

For direct data import from PreSTo only data for four of these components can be provided: fuselage, wing 1, horizontal tail and vertical tail. Especially regarding engine definition two facts are worth mentioning:

1. As engine definition is currently not being executed within PreSTo the integrated workflow using PreSTo and CEASIOM comes to a stop here. At this stage, engines have to be defined and the user is not offered any support by PreSTo yet.
2. Although turboprop engines may already be selected as engine type inside CEASIOM (although nowhere explained to the user; see below) propeller engines cannot be

displayed and defined by the user. The engine definition sections are focused on the specification of jet engines. In how far turboprop or propeller engines in general may be investigated in the following design modules is not specified.

## **Fuselage**

The geometry of the fuselage is defined by 15 parameters such as the vertical position of the tail and nose tip (defined as angles in the x-z plane), vertical and horizontal fuselage diameters and the total fuselage length. From these parametric and explicit input data further detailed explicit aircraft dimensions such as the lengths of the nose and tail cones are calculated. All of the required input data are provided by the PreSTo export file. However, some data are set to default value so that, e.g. the nose and tail tips are always located at the vertical position of the maximum fuselage thickness.

## **Wing**

The wing definition section uses about thirty parameters such as area, span dihedral, leading edge sweep, etc. to describe a wing with a maximum of two kinks. For winglet, flap, aileron, slat and fairing definition additional parameters are used. In this context it is important that the kink positions and the flap and aileron positions are not independent. In AcBuilder the flaps always extend from the wing root to kink 2. Also the aileron positioning occurs relative to kink 2. Position 0 means from kink 2 outwards, position 1 means from wingtip inwards, and position 2 means centered between kink 2 and wingtip. In consequence, also for aircraft with no or only one kink in the wing plan two kinks must be defined. In case kink positions and flap and aileron positions of a reference aircraft differ these differences cannot be included into the AcBuilder model. With respect to the connection of CEASIOM to PreSTo it is important that PreSTo allows for only one wing kink but a completely free positioning of ailerons and flaps. Moreover, in PreSTo also inboard high-speed ailerons could be defined that could not be modeled with AcBuilder.

The airfoil sections used at the wing positions root, kink 1, kink 2 and tip are selected from a list of available airfoil definition files. Hence, the airfoils used have to be defined in simple (non-xml) first so that in the AcBuilder geometry input section their complete filenames including file type ending (e.g. B747100\_0303span.dat) can be selected by the user. The airfoil geometry files must be stored in the CEASIOM folder ...\\CEASIOM\\ceasiom100-v2\_0\\Geometry\\airfoil. This file must contain parametric geometry data of the airfoil upper and lower contour as given in the following example (NACA 23018):

```
1          0.0019
0.95      0.0132
0.9       0.0239
0.8       0.044
[...]
```

0.05	0.0692
0.025	0.0529
0.0125	0.0409
0	0
0.0125	-0.0183
0.025	-0.0271
0.05	-0.038
[...]	
0.9	-0.0194
0.95	-0.0109
1	0

Some additional control parameters such as “Reference\_convention” and “Configuration [0,1,...]” have to be defined by the user for a correct wing definition. However, the exact meanings and influences of these parameters (as well as further ones from various definition sections) are not explained in the AcBuilder GUI, and also the AcBuilder help file “AcBuilder-tutorial.pdf” (**Lahuta 2010**, available from the CEASIOM installation folder ...\\CEASIOM\\ceasiom100-v2\_0\\Documentation\\AcBuilder) is incomplete and incorrect in some cases.

### **Horizontal and vertical tail**

The definitions of the horizontal and vertical tails are principally similar to the definition of a wing. The differences are that only one kink may be defined and that only an elevator or rudder are the only possible trailing edge devices. Inside PreSTo it is not possible to define a kink in the horizontal tail or twist of the stabilizers. The elevator and rudder are positioned as centered between stabilizer roots and tips.

### **Weights & Balance**

In the weights & balance section the user has to define at least 17 mandatory aircraft parameters concerning the aircraft cabin and passenger accommodation. Moreover, about 100 additional mass properties of different system components can be defined. In case no user input is given AcBuilder estimates these values automatically.

### **Import Result**

The result of the data export from PreSTo to AcBuilder is shown in Figure 4.2. It can be seen that the geometries of the fuselage nose and tail cone are much simplified. Most importantly the apexes of the cones are not moved in z-direction. In consequence the tailplane, though positioned correctly, is not connected to the fuselage. Also the geometry of the vertical tail is simplified. The two kinks of the original ATR 72 have not been modeled in PreSTo.



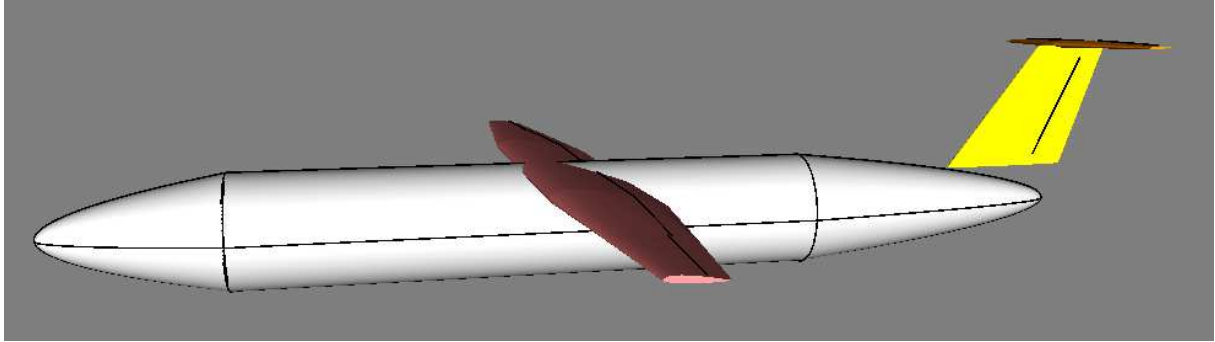

**Figure 4.2** PreSTo Result Imported into AcBuilder – 1

Figure 4.3 shows the aircraft cabin of the re-designed ATR 72. The cabin definition is of acceptable quality for the estimation of the position of the overall center of gravity. The only problem and inaccuracy lies in the position of the flight deck. Inside AcBuilder the flight deck is regarded as part of the aircraft cabin (red seats in Figure 4.3).

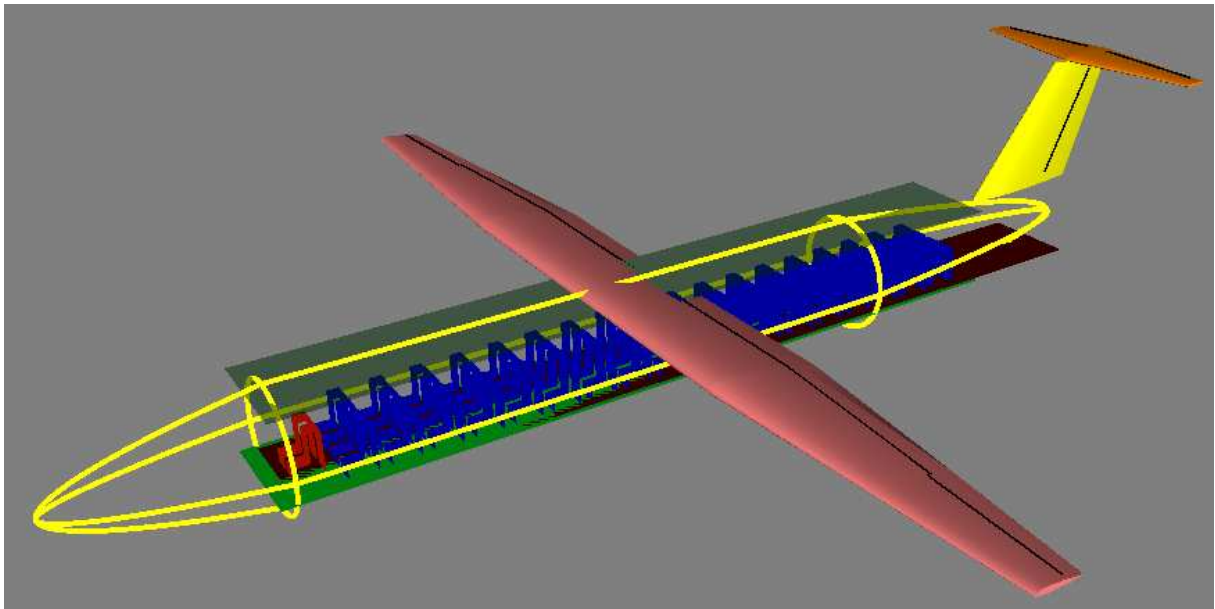

**Figure 4.3** PreSTo Result Imported into AcBuilder – 2

### 4.1.2 Aircraft Model Modification

The initial geometry requires a manual modification of the tail geometry to connect the tailplane to the aircraft fuselage. The value “phi\_tail” of the fuselage is set from  $0^\circ$  to  $5^\circ$  to rise the tail tip of the fuselage. In addition vertical and horizontal tail are moved forward (values “apex\_locale” of vertical tail and horizontal tail set from 0.887 and 1.005 to 0.85 and 0.968).

As engines are currently not treated in PreSTo they are added manually to the aircraft model in order to further analyze the aircraft with the following tools and generate a complete data set. It was selected:

- Layout\_and\_config: 0 (=slung in vicinity of the wing)
- Propulsion\_type: 1 (= turboprop tractor (**Puelles 2010**))
- Thrust-to-weight ratio: 5.5 (assumption; at 42 kN max. take-off thrust)

As mentioned earlier it is not clear for the user if engines selected to be propeller engines are really treated as such inside CEASIOM. Figure 4.4 shows the aircraft geometry after modification. It can be seen that the propellers are not being displayed.

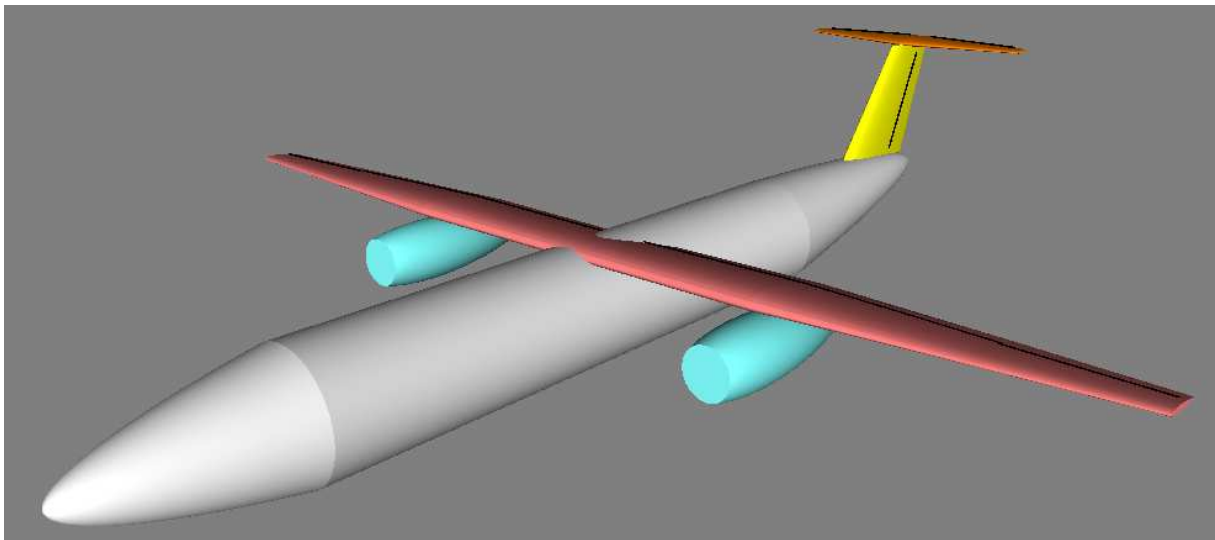

**Figure 4.4** Aircraft Geometry after Modification

The AcBuilder section “Geometry -> Fuel” offers the possibility to specify different fuel tank volumes and masses. Figure 4.5 shows the data of the ATR 72 re-design.

Fuel		
Fuel tanks definition		
Wingbox definition		
Parameters		
Parameter	Unit	Value
Maximum_fuel_in_wings	kg	5000,0
Maximum_fuel_in_auxili...	kg	0,0
Maximum_fuel_in_cent...	kg	0,0
Maximum_fuel_weight	kg	5000,0
Fuel_to_MTOW_at_maxi...	kg	2000,0
Outboard_fuel_tank_span	[0-1]	0,7
Wing_fuel_tank_cutout_...		0,0
Unusable_fuel_option		44,3
Assumed_fuel_density	kg/m <sup>3</sup>	0,809
Incr_weight_for_wing_ta...		0,0
Centre_tank_portion_us...		85,25
Increment_for_centre_t...		0,0
Fore_fairing_tank_length	[0-1]	0,5
Aft_fairing_tank_length	[0-1]	0,5
Aft_fuse_bladder_length		0,0
Increment_for_aux_tanks		0,0
Aux_wing_spar_loc_root	[0-1]	0,0

Figure 4.5 Specification of Fuel Tanks and Masses

### 4.1.3 AcBuilder Results

#### Geometry

Based on the data exported from PreSTo and the manual user input AcBuilder calculates overall geometric aircraft data such as the mean aerodynamic chord (MAC) of the wing (Geometry -> Geometry (output), see Figure 4.6). These out values can be checked by the user and are calculated correctly for the present example.

Parameters		
Parameter	Unit	Value
taper_ratio		0,32796
planform_AR		11,6406
Weighted_area	m <sup>2</sup>	62,3477
LE_sweep	deg.	3,3874
MAC	m	2,5119
relative_apex		0,42158
Orig_root_chrd_at_ac_CL		2,7282
Half_chord_sweep	deg.	-1,59
Quarter_chord_sweep	deg.	0,90039
non_dim_MAC_y_bar		0,41566
Weighted_aspect_ratio		11,6406
mean_thickness		0,1

Figure 4.6 Overall Geometric Results

## Weight and Balance

For the following flight mechanical CEASIOM modules the geometry data have to be combined with mass properties of the aircraft model. The corresponding AcBuilder weight and balance section is very comprehensive and many detailed system and component masses may be specified by the user. From these input data overall aircraft masses are calculated by the tool automatically during the center of gravity (CG) estimation. The way this is performed or the methodologies applied are not specified in the user interface or in the available CEASIOM documentation. Moreover, the non-modified version of CEASIOM 100 R90 delivers partly significantly wrong numbers for the overall aircraft masses. In the present example the maximum take-off mass of the ATR 72-based reference aircraft is estimated as 600 t; the real value is about 22 t. (Note: This problem is known to the software developers, and a corresponding software patch is available for download and installation from the CEASIOM website **CEASIOM 2010a**).

## Technology

The technology section of AcBuilder generates models for the following CEASIOM modules for aerodynamics and aeroelasticity investigations. The generated structural beam model and the aerodynamic panel model are shown in Figure 4.7 and 4.8.

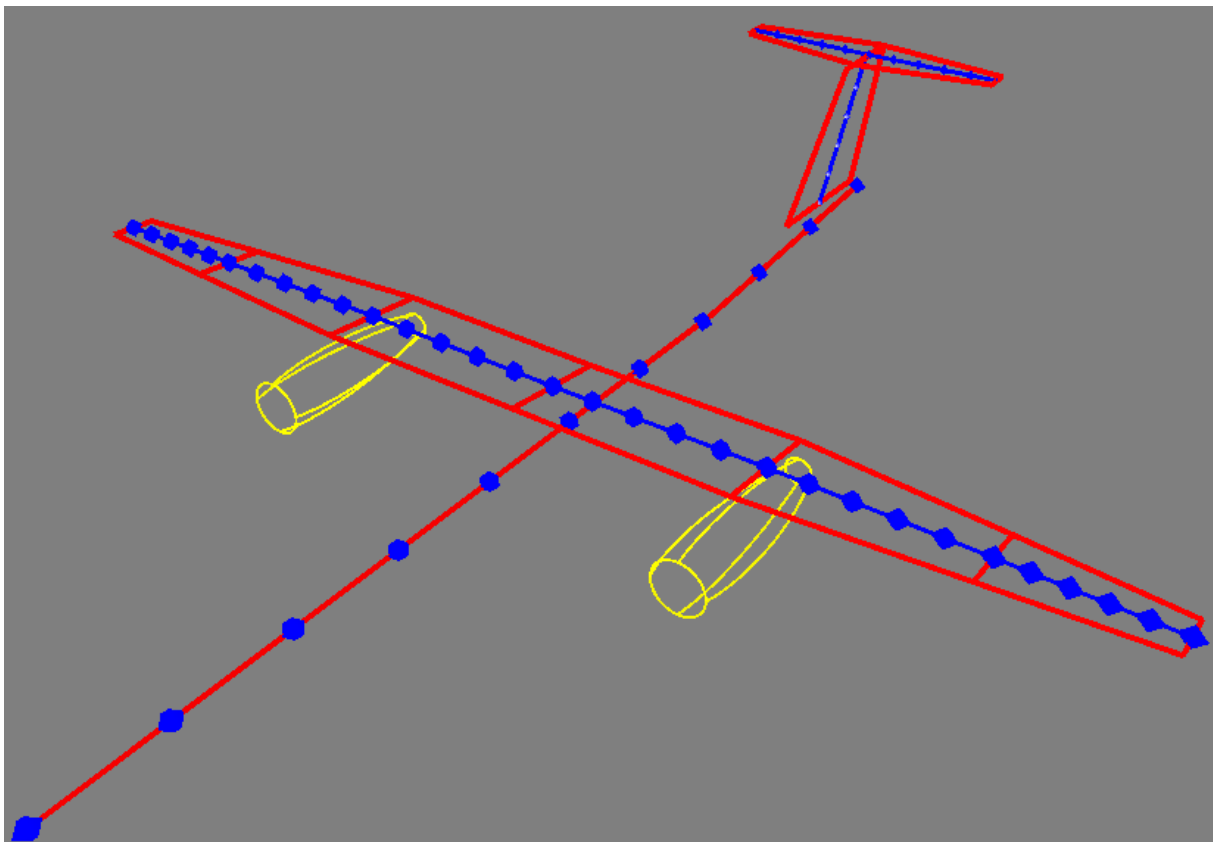

**Figure 4.7** Structural Beam Model

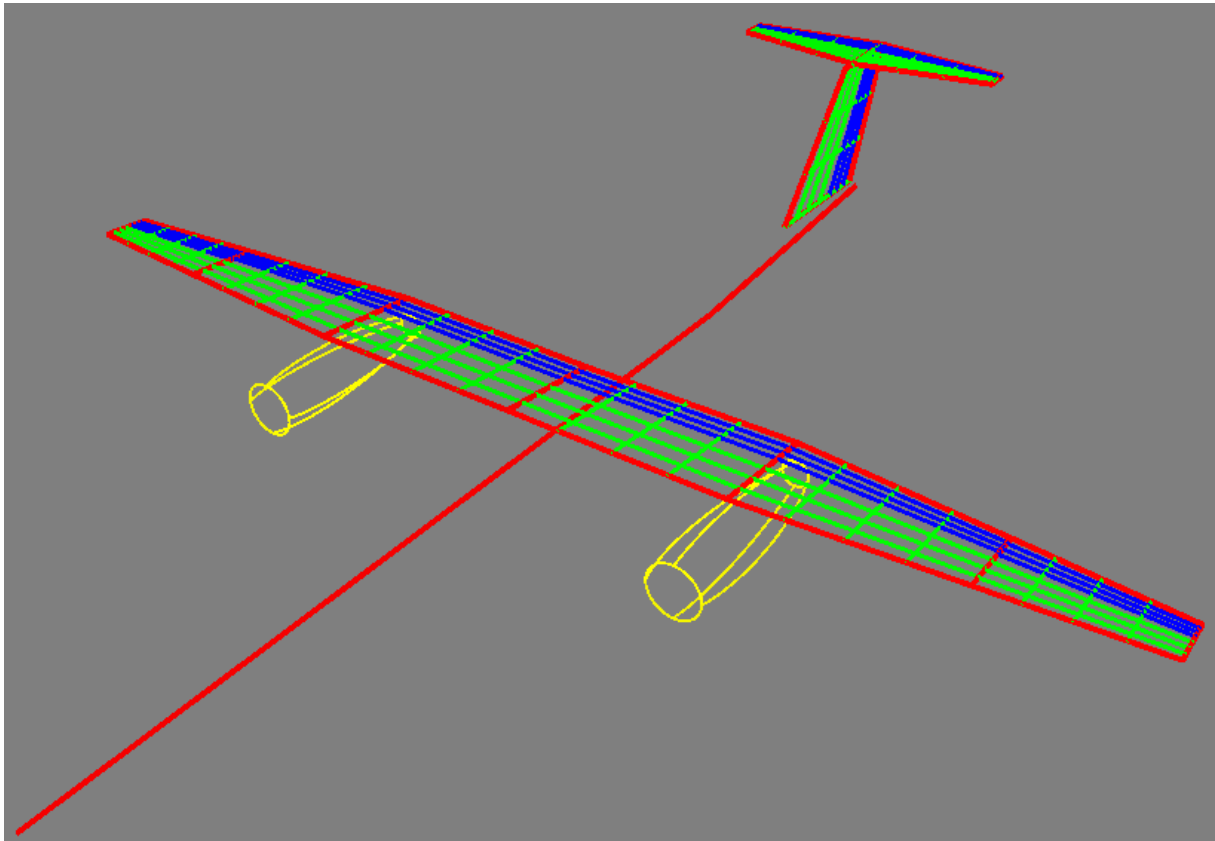

**Figure 4.8** Aerodynamic Panel Model

## 4.2 Geometry Export to SUMO

Figure 4.9 shows the result of the geometry export from AcBuilder to SUMO. The generation of a surface mesh could be performed for (different versions) of the present aircraft model, but the resulting mesh always resulted as faulty (see examples of error messages in Figures 4.10 to 4.11). Moreover, if the engine layout and configuration was selected as 1 (meaning on-wing nacelle, **Puelles 2010**) the position of the engines inside SUMO was even completely different to the one specified in AcBuilder. Due to the faultiness of the different surface meshes, it was not possible to generate a volume mesh for detailed CFD analyses using SUMO. The Figures 4.12 and 4.13 show exemplary SUMO error messages.

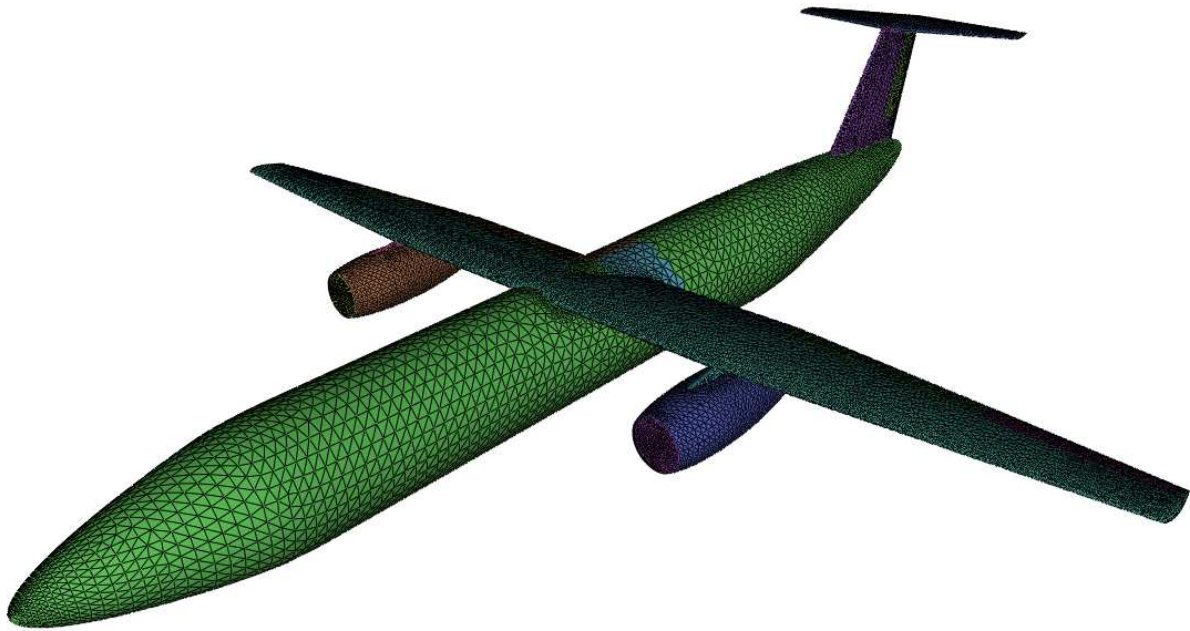

Figure 4.9 SUMO Aircraft Model and Surface Mesh

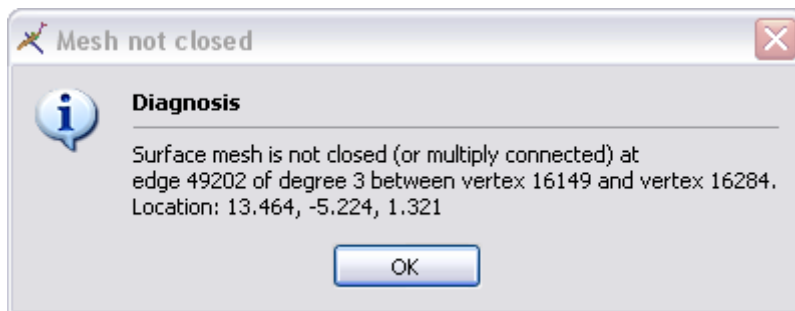

Figure 4.10 SUMO Example of Surface Mesh Error Messages – 1

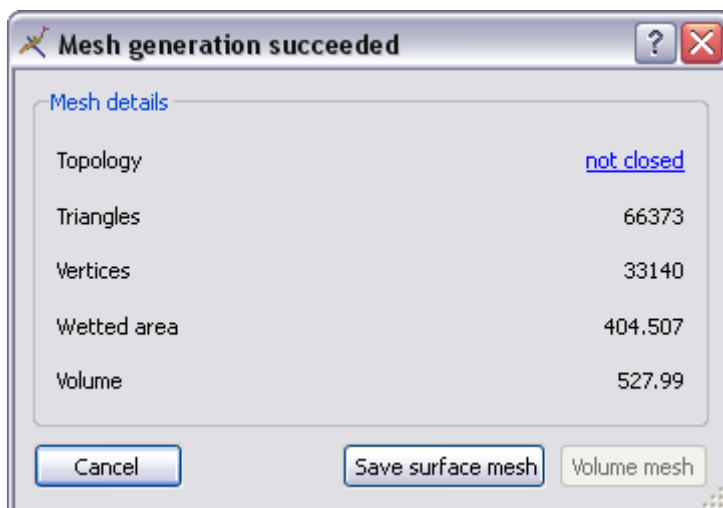

Figure 4.11 SUMO Example of Surface Mesh Error Messages – 2



Figure 4.12 SUMO Example of Volume Mesh Error Messages – 1

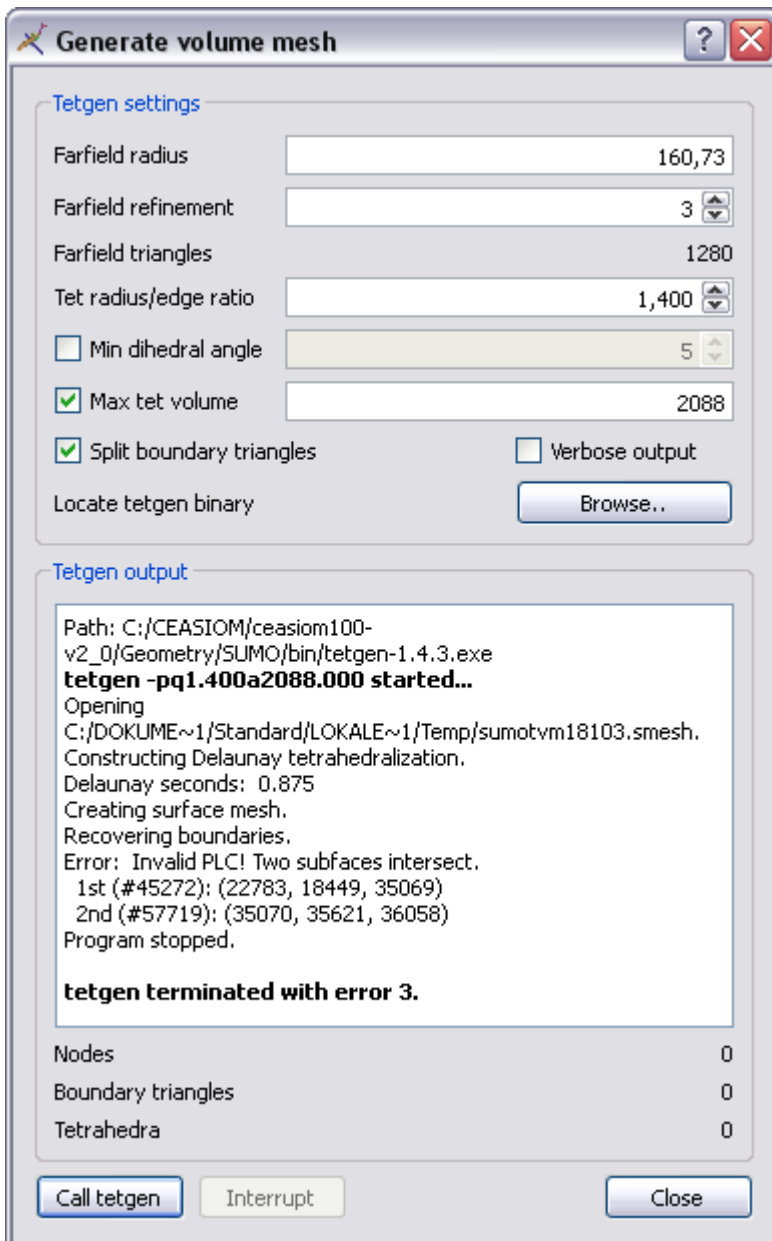

Figure 4.13 SUMO Example of Volume Mesh Error Messages – 2

### 4.3 Aerodynamic Investigation with AMB

For simplified aerodynamic investigations of the aircraft model based on DATCOM and the potential solver Tornado it is possible run AMB without detailed surface and volume meshes generated by SUMO. However, the defined and displayed geometry of the present ATR 72 example from AcBuilder could not be used to generate a Tornado geometry (see Figures 4.14 and 4.15). An explanation of what/where the wrong input parameter is/are is not given to the user. The source code is also not available to the user to check in a debug mode.

```

??? Error using ==> svd
Input to SVD must not contain NaN or Inf.

Error in ==> cond at 40
    s = svd(A);

Error in ==> solver9 at 54
results.dwcond=cond(w2);

Error in ==> solverloop5 at 625
    [results]=solver9(results,state,geo,lattice,ref);

Error in ==> tornadowrap2 at 123
solverloop5(acproject.AMB.tornadorun.results,jobtype,JID,acproject.AMB.tornado.lattice,state,geo,acproject.AMB.tor
%Solving

Error in ==> C:\CEASIOM\ceasiom100-v2_0\Aerodynamics\AMB\Call_Tornado.p>Call_Tornado at 133

Error in ==> C:\CEASIOM\ceasiom100-v2_0\Aerodynamics\AMB\AMB.p>plot_tornado_call at 843

??? Error while evaluating uicontrol Callback
>> |

```

**Figure 4.14** Example of MATLAB Error Messages (AMB: GEO TORNADO) – 1

```

??? Error using ==> load
Unable to read file NACA23018: No such file or directory.

Error in ==> fLattice_setup2>slope3 at 1090
    A=load(char(foil));

Error in ==> fLattice_setup2>geometry19 at 679
[X_1_S,lemma_1_S_tot]=slope3(foil(1,1,1)); %element inboard camber slope

Error in ==> fLattice_setup2>geosetup15 at 168
[C V N2 P]=geometry19(geo.fnx(s,t),geo.ny(s,t),geo.nx(s,t),...

Error in ==> fLattice_setup2 at 60
    [lattice,ref]=geosetup15(geo);

Error in ==> C:\CEASIOM\ceasiom100-v2_0\Aerodynamics\AMB\Call_Tornado.p>Call_Tornado at 94

Error in ==> C:\CEASIOM\ceasiom100-v2_0\Aerodynamics\AMB\AMB.p>plot_tornado_call at 843

??? Error while evaluating uicontrol Callback

```

**Figure 4.15** Example of MATLAB Error Messages (AMB: GEO TORNADO) – 2

When using DATCOM as AMB aerodynamics solver the calculated results for the aircraft model underlying this report lead to the charts presented in Figures 4.16 and 4.17. It can be seen that that the tool calculates minimum drag values of about 0.02 for the whole aircraft at about  $-2^\circ$  to  $-3^\circ$  angle of attack, and a maximum value of about 0.065 is determined for about



11° to 12° angle of attack (Figure 4.16). These results and especially the overall shape of the graph are clearly unrealistic. The same is true for the development of the lift coefficient shown in Figure 4.17.

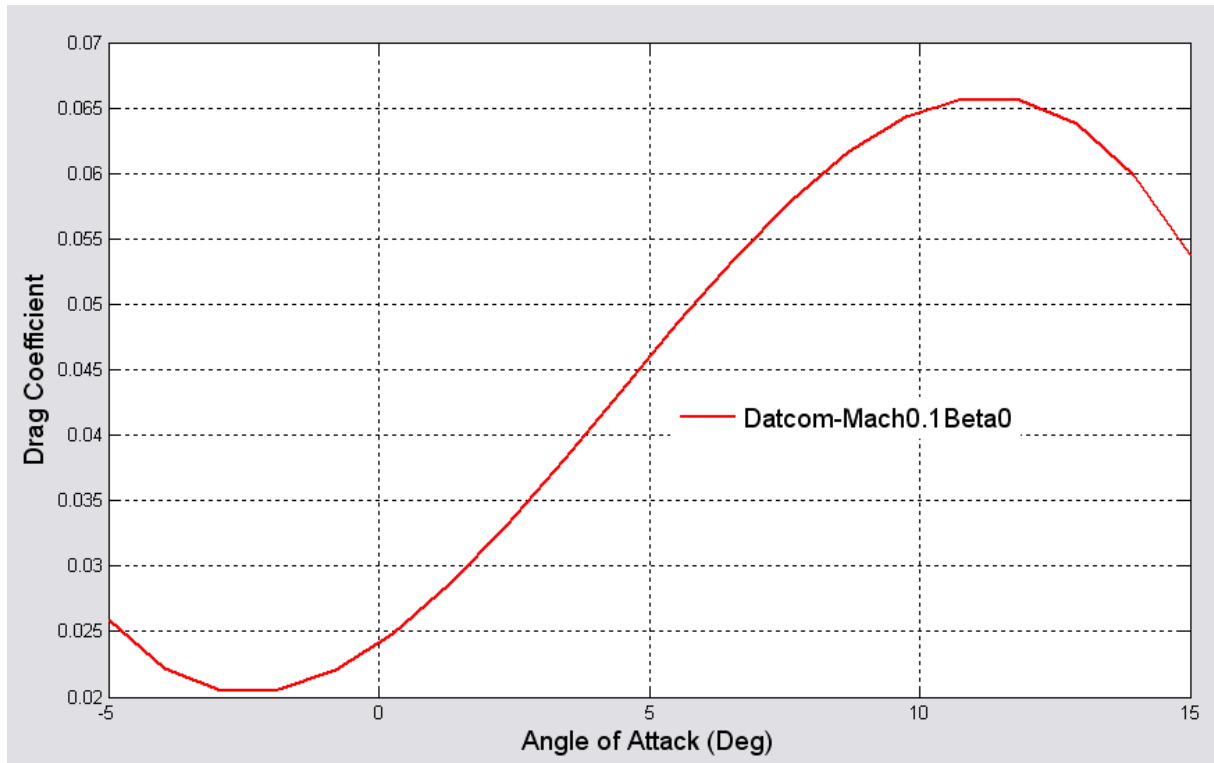

Figure 4.16 AMB Drag Coefficient Result (DATCOM)

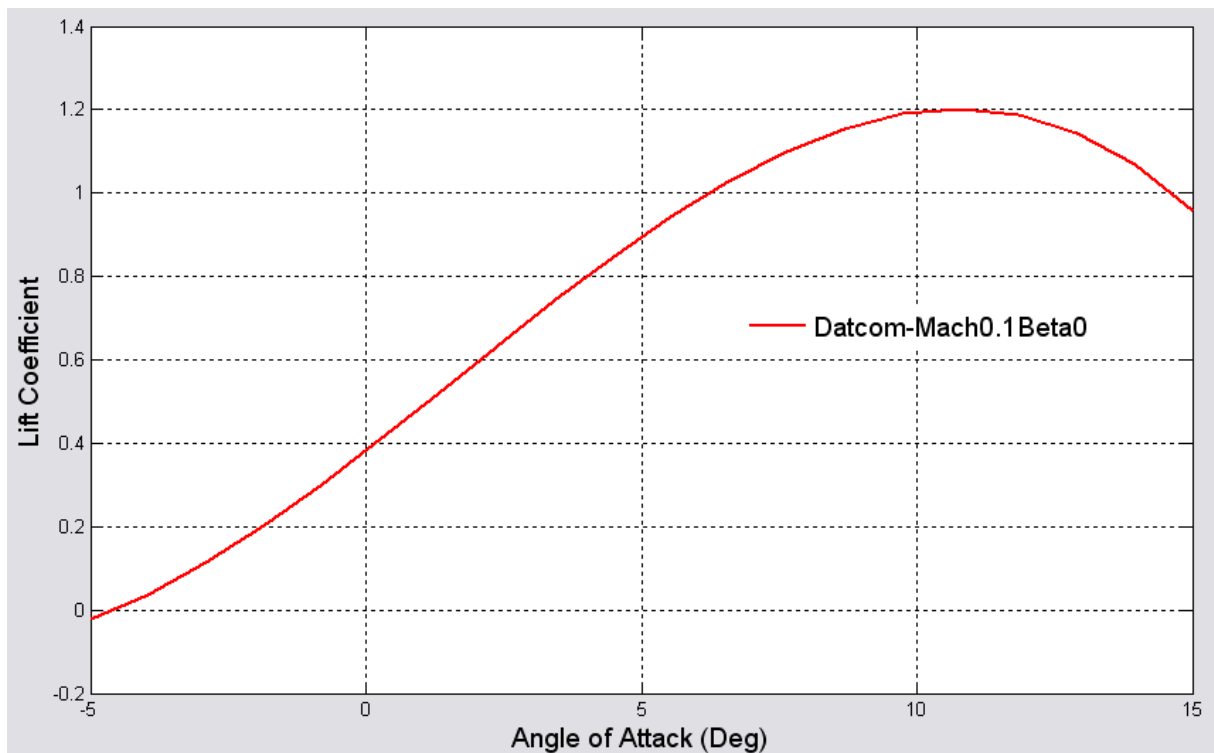

Figure 4.17 AMB Lift Coefficient Result (DATCOM)

## 5 Findings and Future Work

This section collects the most important findings such as software errors and problems during the application of the tools that should be treated during the future work on PreSTo and CEASIOM.

### PreSTo

- Some data collected in sheet CEASIOM do not refer to variable names but cell positions. Thus, changes in the worksheets may cause wrong links!
- Some AcBuilder input data are not defined in PreSTo yet (e.g. engines (!) or fuselage and vertical tail geometry). Thus incomplete AcBuilder data input set.
- Geometry of fuselage nose and tail cone simplified. No nose shape, apexes in standard (center) position.
- Cabin attendants and attendant seats not treated in PreSTo yet.
- Geometry of vertical tail simplified. No kinks.
- In sheet “High-lift” it is not possible to select that no flaps shall be designed.
- In cell Wing D54, automatic calculation deleted.
- Error in name definition in sheet “Tailplane\_I”! Incidence angle is called "dihedralV"; direction of an incidence angle not defined
- Seats abreast and seat pitch: value of Economy Class taken
- Orthographic mistakes (e.g. ‘outter’ in sheet ‘Fuselage’, Capitals throughout many sheets)

### CEASIOM general

- Although turboprop engines may already be selected as engine type inside CEASIOM propeller engines cannot be displayed and defined by the user. The engine definition sections (AcBuilder) are focused on the specification of jet engines. In how far turboprop or propeller engines in general may be investigated in the following design modules is not specified in any CEASIOM documentation.
- It is important to store the central xml-file after each individual tool to avoid calculation errors.
- Errors and/or contradictive information on units to be entered between xmlFileDefinition and AcBuilder GUI (e.g. Target\_operating\_ceiling m vs. FL)
- Once a project has been selected or created at the beginning of a CEASIOM session the user cannot switch to different project but has to restart CEASIOM.
- Errors occur without explanation to the user which parameter causes (might cause) this error.
- Aircraft designs with two wings may be defined in AcBuilder but not investigated any further from that module.

## AcBuilder

- The investigations of CEASIOM underlying this report as well as previous studies with CEASIOM have shown that it is very important for the user to follow the specified workflow. Changes in the order of the executed modules or missing modules cause inconsistent data in the created xml-file. Such errors inhibit the further use of the aircraft model in the following CEASIOM modules, and the aircraft definition has to be performed once more.
- Help file (AcBuilder-tutorial.pdf **Lahuta 2010** in folder ...\\CEASIOM\\ceasiom100-v2\_0\\Documentation\\AcBuilder) incomplete, no definition of input data
- With respect to the connection of CEASIOM to PreSTo it is important that PreSTo allows for only one wing kink but a completely free positioning of ailerons and flaps. Moreover, in PreSTo also inboard high-speed ailerons could be defined that could not be modeled with AcBuilder.
- Flaps can only extend between root and kink positions. I. e. at the flap end, there must be a kink.
- Partly wrong units required in user input section
- Different units of user input (e.g. sometimes 0-1, sometimes %),
- Input data partly parametric, partly related to units (e.g. aileron span in m although everything else is defined parametrically): aileron span says [m], but must be [-]
- Total operating ceiling and cabin altitude defined. So why also max. pressure differential?
- The flight deck is treated as part of the cabin.
- The weight and balance section does not work correctly. Manual input data are not accepted.
- Orthographic mistakes (e.g. in AcBuilder input section, Capitals)

## SUMO

- Generated surface mesh faulty
- Generation of volume mesh not possible
- Different engine positions to those in AcBuilder (if layout and configuration is selected as 1)

## AMB

- DATCOM results are unrealistic under certain conditions. E.g. the investigation of a modern supercritical airfoil leads to a positive zero-lift angle (see **Pester 2010**).
- Problem with self-defined airfoils although exactly the same input format as available template files and realistic contour.
- The defined and displayed geometry from AcBuilder cannot be used to generate a Tornado geometry.
- Orthographic mistakes (e.g. in AcBuilder input section, Capitals)

## Summary and Conclusions

The connection of PreSTo and CEASIOM for a user-friendly tool chain from aircraft preliminary sizing to aerodynamic investigation and simulation appears promising due to the possibility of data exchange in the form of an xml-file. However, before this tool chain becomes reality and offers the potential for realistic and trustworthy results both software sides need extensions and improvements. Thus, for the combination of PreSTo and CEASIOM a close collaboration of the developing teams and a previous information exchange, e.g. in the form of a developers workshop, appears advisable.

In the current state PreSTo allows the user to re-design or set up new conventional aircraft designs from initial TLARs posed to the tentative new aircraft. The determination of an aircraft design point in terms of wing loading and power-to-mass or thrust-to-weight ratio is followed by a stepwise definition of the individual aircraft components starting with the fuselage, wing and the tailplane. As a detailed engine specification is currently not incorporated into PreSTo yet, this important design feature cannot be exported to CEASIOM yet. Moreover, a constant workflow from PreSTo to AcBuilder with minimized user input inside CEASIOM, for example, makes it necessary to include mandatory AcBuilder data already into PreSTo. Furthermore, such an early parameter definition would significantly reduce the amount of error sources and reasons for CEASIOM and/or Matlab software crashes compared to the current state.

At the time of writing this report there are still many inaccuracies, such as the lift and drag results of AMB, and difficulties regarding the correct application of CEASIOM (version v2.0 or version 100 R90). Here additional and/or new user tutorials would be helpful. The current documentation is partly rough and incomplete or outdated. Currently, it is mandatory for the user to have detailed knowledge on the individual modules of CEASIOM and their way of working in order to operate the program correctly. For a user not personally involved in the development of CEASIOM this makes the workflow complicated and unclear.

In the CEASIOM version underlying this report the possibility to investigate propeller aircraft has been principally prepared but cannot be regarded as complete or final. Propellers are not displayed inside the AcBuilder aircraft model, and the required input data are focused on jet engines. In how far the CEASIOM module Propulsion could already account for the engine characteristics of a propeller engine over speed and altitude (e.g. development shaft power instead of thrust) is not specified in the documentation. Within the scope of this report the engines, although selected to be turboprop engines, appeared to be handled as jet engines.

## References

### **ATR 2003**

AVIONS DE TRANSPORT RÉGIONAL: The New Standard in Regional and Feeder Cargo Transport – The Tube. Corporate Information, 2003. – URL: <http://www.atraircraft.com/public/atr/html/media/medias.php?aid=757> (2008-05-27)

### **ATR 2003a**

AVIONS DE TRANSPORT RÉGIONAL: ATR large cargo door. Corporate Information, 2003. – URL: <http://www.atraircraft.com/public/atr/html/media/medias.php?aid=757> (2008-05-27)

### **ATR 2005**

AVIONS DE TRANSPORT RÉGIONAL: ATR 42-300/320 and ATR 72-200/210 – The regional way to profitability. Corporate Information, 2005. – URL: <http://www.atraircraft.com/public/atr/html/media/medias.php?aid=757> (2008-06-05)

### **Cavagna 2009**

CAVAGNA, L.; RICCI, S.; RICCOBENE, L. and DE GASPARI, A.: NeoCASS 1.3 – Overview and GUIs Tutorial (Rel.1), NeoCASS Training Meeting, PoliMI, Milano, March 23-24, 2009

### **CEASIOM 2010**

CEASIOM WEBSITE – URL: <http://www.ceasiom.com/ceasiom-modules.html> (2010-12-16)

### **CEASIOM 2010a**

CEASIOM WEBSITE: CEASIOM: Computerised Environment for Aircraft Synthesis and Integrated Optimisation Methods – URL: <http://www.ceasiom.com/> (2010-12-16)

### **Coene 2008**

COENE, S.: Conceptual Design of Wings and Tailplanes – Methods, Statistics, Tool Setup. Hochschule für Angewandte Wissenschaften Hamburg, Department Fahrzeugtechnik und Flugzeugbau, Master Thesis, 2008

### **EASA 2010**

European Aviation Safety Agency: Certification Specifications for Large Aeroplanes – CS-25, Amendment 10, 17 December 2010. –URL: <http://www.easa.eu.int/agency-measures/docs/agency-decisions/2010/2010-013-R/CS-25%20Amdt%2010.pdf> (2011-02-08)

**FAA 2011**

FEDERAL AVIATION ADMINISTRATION: PART 25—AIRWORTHINESS STANDARDS: TRANSPORT CATEGORY AIRPLANES – URL: <http://ecfr.gpoaccess.gov/cgi/t/text/text-idx?c=ecfr&sid=be6ffa6d87343c75e7d49e911c95ab06&rgn=div5&view=text&node=14:1.0.1.3.11&idno=14> (2011-02-08)

**Hoak 1978**

HOAK, D. E.: USAF Stability and Control Datcom, Wright Patterson Air Force Base, Air Force Flight Dynamics Laboratory, Flight Control Division, Ohio, 1978

**Howe 2005**

Howe, D.: Aircraft Conceptual Design Synthesis. London : Professional Engineering Publishing, 2005

**Jackson 2008**

JACKSON, Paul (ed.): Jane's All the World's Aircraft 2008-2009. Jane's Information Group, 2008.

**Lahuta 2010**

LAHUTA, Martin: User manual for AcBuilder – input tool for CEASIOM software.

**Lenarczyk 2009**

LENARCZYK, M.: Preliminary Sizing of Propeller and Jet Aircraft – Extension of PreSTo and Combination with CEASIOM. Hochschule für Angewandte Wissenschaften Hamburg, Department Fahrzeugtechnik und Flugzeugbau, Project, 2009

**Markwardt 1998**

MARCKWARDT, K.: Unterlagen zur Vorlesung Flugmechanik I. Fachhochschule Hamburg, Fachbereich Fahrzeugtechnik, Lecture Notes, 1998

**Melin 2000**

MELIN, T.: A Vortex Lattice MATLAB Implementation for Linear Aerodynamic Wing Applications. Royal Institute of Technology (KTH), Department of Aeronautics Master Thesis, December 2000. – URL: <http://www.redhammer.se/tornado/thesis.pdf> (2011-02-08)

**Montarnal 2010**

MONTARNAL, P.: PreSTo-Cabin – A Preliminary Sizing Tool for Passenger Aircraft Cabins Documentation and User's Manual. Bishop GmbH, 2010

**Niță 2008**

NIȚĂ, Mihaela. F: Aircraft Design Studies Based on the ATR 72. Hochschule für Angewandte Wissenschaften Hamburg, Department Fahrzeugtechnik und Flugzeugbau, Project, 2008

**Pommers 2010**

POMMERS, M.: Entwicklung einer Methode für die automatische Visualisierung von Flugzeugentwürfen in einem 3D-CAD-Modell auf der Basis von variablen konstruktiven Parametern. Hochschule für Angewandte Wissenschaften Hamburg, Department Fahrzeugtechnik und Flugzeugbau, Project, 2010

**Puelles 2010**

PUELLES, Andrés: CEASIOM XML file Definition. Royal Institute of Technology, Stockholm, February 2010

**Roskam 1990**

ROSKAM, J.: Airplane Design. Vol. 1 - 8, Ottawa, Kansas, 1990

**Scholz 2005**

Scholz, D.: Flugzeugentwurf. Hochschule für Angewandte Wissenschaften Hamburg, Department Fahrzeugtechnik und Flugzeugbau, Aircraft Design and Systems Group (Aero), Lecture Notes, 2005

**Scholz 2008**

Scholz, D. (ed.): Aircraft Design. Hamburg University of Applied Sciences, Department of Automotive and Aeronautical Engineering, Aircraft Design and Systems Group (Aero), Short Course Notes, 2008. – URL: <http://www.flugzeugentwurf.de> (2011-02-08)

**Scholz 2010**

Scholz, D.: GF – Grüner Frachter – Entwurfsuntersuchungen zu umweltfreundlichen und kosteneffektiven Frachtflugzeugen mit unkonventioneller Konfiguration. – URL: <http://GF.ProfScholz.de> (2010-07-07)

**Scholz 2010a**

Scholz, D.: Abgegeben: Diplomarbeiten und Projekte – "Digitale Bibliothek". – URL: <http://www.fzt.haw-hamburg.de/pers/Scholz/ArbeitenAbgegeben.html> (2011-02-08)

**Scholz 2010b**

Scholz, D.: Vorlesung Flugzeugentwurf. – URL: <http://FE.ProfScholz.de> (2010-07-15)

**Scholz 2010c**

Scholz, D.: PreSTo - Preliminary Sizing Tool – Aircraft Design Spreadsheet Calculation – URL: <http://PreSTo.ProfScholz.de> (2011-02-08)

**Seeckt 2008**

SEECKT, K.: Aircraft Preliminary Sizing with PreSTo. Kungliga Tekniska Högskolan (KTH, Royal Institute of Technology), Department of Aeronautics, Stockholm, Sweden, Project, 2008

**Seeckt 2009**

SEECKT, K. and GÓMEZ-CARRASCO, F: Investigation of the ATR 72 in CEASIOM-50. Presentation. SimSac Design Workshop, Simulating aircraft Stability And Control, Liverpool, United Kingdom, 27 – 29 April 2009

**Seeckt 2009a**

SEECKT, K. and SCHOLZ, D.: Jet versus Prop, Hydrogen versus Kerosene for a Regional Freighter Aircraft. In Deutscher Luft- und Raumfahrtkongress 2009 : Tagungsband – Ausgewählte Manuskripte , Aachen, Germany, September 2009. DGLR – Deutsche Gesellschaft für Luft- und Raumfahrt. ISBN 978-3-932182-63-4

**Seeckt 2010**

SEECKT, K. and SCHOLZ, D.: Application of the Aircraft Preliminary Sizing Tool PreSTo to Kerosene and Hydrogen Fueled Regional Freighter Aircraft. In Deutscher Luft- und Raumfahrtkongress 2010 : Tagungsband – Manuskripte, Hamburg, Germany, August/September 2010. DGLR – Deutsche Gesellschaft für Luft- und Raumfahrt. ISBN 978-3-932182-68-5

**Seeckt 2010a**

SEECKT, K.; HEINZE, W. and SCHOLZ, D.: Hydrogen Powered Freighter Aircraft – The Final Results of the Green Freighter Project. In ICAS 2010 – 27th Congress of the International Council of the Aeronautical Sciences, Nice, France, September 2010. International Council of the Aeronautical Sciences, Optimage Ltd. ISBN 978-0-9565333-0-2.

**Torenbeek 1988**

TORENBEEK, E.: Synthesis of Subsonic Airplane Design, Delft : Delft University Press, 1988

**Wikipedia 2010**

WIKIPEDIA.ORG: URL: [http://de.wikipedia.org/wiki/ATR\\_72](http://de.wikipedia.org/wiki/ATR_72) (2010-12-17)

**Wolf 2009**

WOLF, S.: Erweiterung des „Aircraft Preliminary Sizing Tools“ PreSTo. Hochschule für Angewandte Wissenschaften Hamburg, Department Fahrzeugtechnik und Flugzeugbau, Project, 2009